

KOMATSU®

PC1250/1250SP-8R BACKHOE PC1250-8R LOADING SHOVEL

PC
1250

HORSEPOWER

Gross: 514 kW 688 HP / 1800 min⁻¹

Net: 502 kW 672 HP / 1800 min⁻¹

OPERATING WEIGHT

Backhoe: 113500 – 116600 kg

Loading shovel: 116800 kg

BUCKET CAPACITY

Backhoe: 3.40 – 6.70 m³

Loading shovel: 6.50 – 7.20 m³



Photos may include optional equipment.

WALK-AROUND



Photos may include optional equipment.

PRODUCTIVITY, ECOLOGY & ECONOMY

- High Power Komatsu SAA6D170E-5 Engine
- Economy Mode Four-level Setting
- Low Ambient Noise
- Working Mode Selection
- Heavy Lift Mode
- Swing Priority Mode
- Large Digging Force
- High Work Equipment Speed
- Large Drawbar Pull and Steering Force
- Two-mode Setting for Boom
- Shockless Boom Control

RELIABILITY & DURABILITY

- Boom Foot Hoses
- O-ring Face Seals
- Removed Water and Contamination in Fuel
- High-pressure In-line Filtration
- Highly Reliable Electronic Devices
- XS Bucket Teeth

COMFORT & SAFETY

- Large Comfortable Cab
- OPG Top Guard Level 2 (ISO 10262)

KOMTRAX

- Liquid Crystal Display (LCD) Monitor
- KOMTRAX Plus (Optional)

MAINTENANCE

- Easy Checking and Maintenance of Engine
- Easy Cleaning of Cooling Unit
- Large Handrail, Step and Catwalk
- Equipment Management Monitoring System



	PC1250-8R BACKHOE	PC1250-8R LOADING SHOVEL
HORSEPOWER	Gross: 514 kW 688 HP / 1800 min ⁻¹	514 kW 688 HP / 1800 min ⁻¹
	Net: 502 kW 672 HP / 1800 min ⁻¹	502 kW 672 HP / 1800 min ⁻¹
OPERATING WEIGHT	113500 – 116600 kg	116800 kg
BUCKET CAPACITY	3.40 – 6.70 m ³	6.50 – 7.20 m ³

PRODUCTIVITY, ECOLOGY & ECONOMY

Komatsu Technology

Komatsu develops and produces all major components, such as engines, electronics and hydraulic components, in house. With this “Komatsu Technology,” and adding customer feedback, Komatsu is achieving great advancements in technology. To achieve both high levels of productivity and economical performance, Komatsu has developed the main components with a total control system. The result is a new generation of high performance and environment friendly excavators.

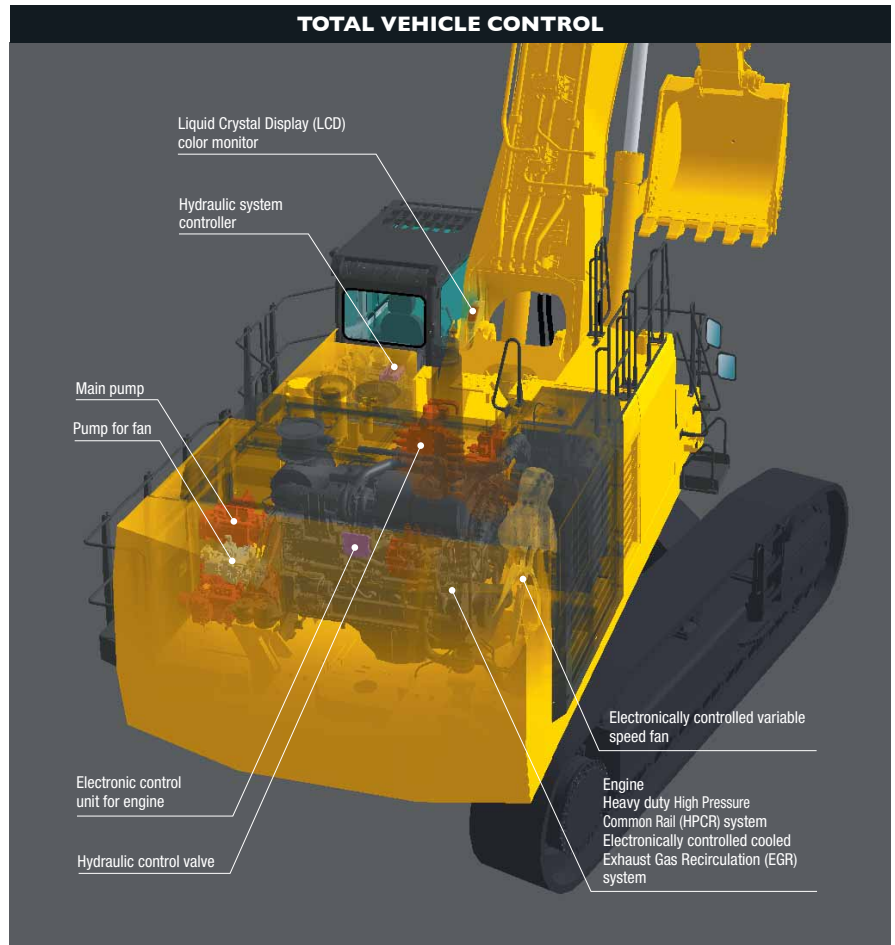
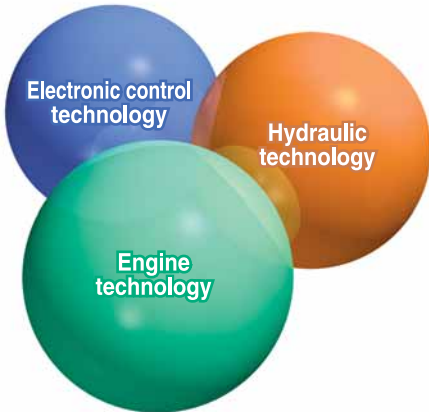

High Power Komatsu SAA6D170E-5 Engine

Powerful turbocharged and air-to-air aftercooled Komatsu SAA6D170E-5 engine provides 502 kW 672 HP. This Komatsu SAA6D170E-5 engine actualizes high-power to low fuel consumption with the optimum fuel injection by electronic heavy duty High Pressure Common Rail (HPCR) fuel injection system.

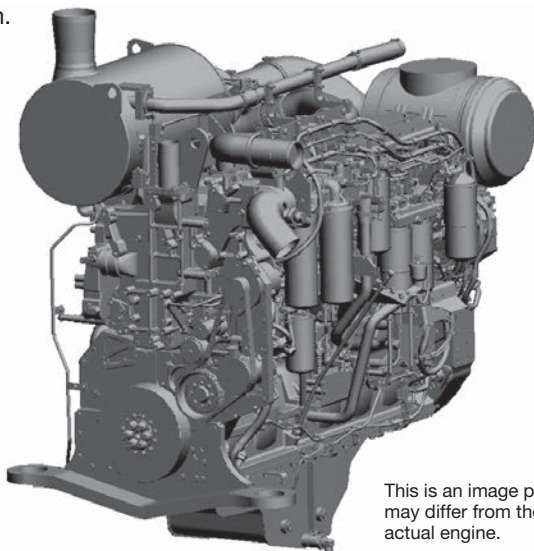

This is an image photo: may differ from the actual engine.

Electronically Controlled Variable Speed Fan Contributes to Low Fuel Consumption and Low Noise

The electronic control system sets the revolution speed of the cooling fan according to the coolant, hydraulic oil, and ambient temperature; effectively uses the engine output to prevent wasteful fuel consumption; and reduces noise during low-speed fan revolution.

Lower and Economical Fuel Consumption Using Economy Mode

Enables operator to set the Economy mode to four levels according to working conditions so that production requirement is achieved at the lowest fuel consumption.

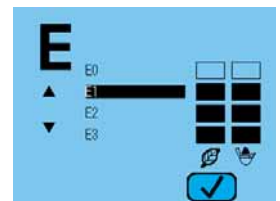

Low Ambient Noise

Reduced noise by adoption of an electronically controlled variable speed fan drive, large hybrid fan and low-noise muffler.

Auto Deceleration

Auto deceleration system is equipped to reduce fuel consumption and operating noise.

Working Modes Selectable

P and E modes established work modes are further improved.

P mode – Power or work priority mode has low fuel consumption, but fast equipment speed and maximum production and power are maintained.

E mode – Economy or fuel saving mode further reduces fuel consumption, but maintains the P-mode-like working equipment speed for light duty work.

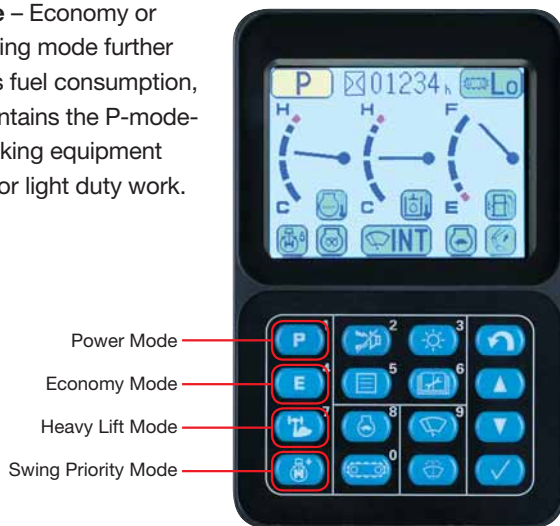

You can select Power or Economy modes using a one-touch button on the monitor panel depending on the workload.

Heavy Lift Mode

Gives 10% more lifting force when needed for handling rock or heavy lifting applications.

Swing Priority Mode

The swing priority mode allows the operator to use the same easy motion for 180° loading as 90° loading operations. By altering the oil flow, this setting allows you to select either boom or swing as the priority for increased production.

Selection	Result
ON	Oil flow to the swing motor is increased. 180° loading operations are most efficient.
OFF	Oil flow to the boom is increased. 90° loading operations are most efficient.

Large Digging Force

Thanks to the high engine output and an excellent hydraulic system, this machine demonstrates powerful digging force.

Maximum arm crowd force (ISO 6015):

412 kN (42.0 t)

Maximum bucket digging force (ISO 6015):

479 kN (48.8 t)

Large Drawbar Pull and Steering Force

Since the machine has a large drawbar pull and a high steering force, it demonstrates excellent mobility even when it is on inclined sites.

Two-mode Setting for Boom

Smooth mode provides easy operation for gathering blasted rock and scraping operations. When maximum digging force is needed, switch to power mode for more effective excavating.

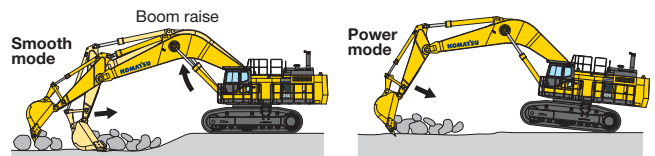

Shockless Boom Control

The PC1250-8R boom circuit features a shockless valve (Double-check slow return valve) to automatically reduces the amount of vibration present when operating the boom. Operator fatigue is reduced (Which can improve safety and productivity), and spillage caused by vibration is minimized.

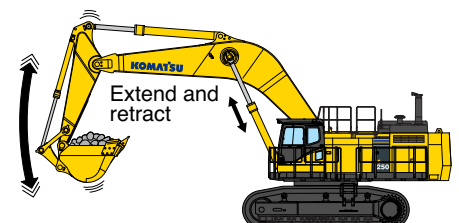

RELIABILITY & DURABILITY

Boom Foot Hoses

The boom foot hoses are arranged under the boom foot to reduce hose bend during operation, extending hose life and improving operator safety.



Frame Structure

The revolving frame mount and center frame mount on the swing circle are no welding structure so that force is transmitted directly to the thick plate of the frame without passing through any welding.

O-ring Face Seal

The hydraulic hose seal method has been changed from a conventional taper seal to an O-ring seal. This provides improved sealing performance during operation.

Fuel Pre-filter (With Water Separator)

Removes water and contaminants from fuel to enhance the fuel system reliability.



High Efficiency Fuel Filter

Fuel system reliability is even better with high efficiency fuel filter.

High-pressure In-line Filtration

The PC1250-8R has the most extensive filtration system available, providing in-line filters as standard equipment. An in-line filter in the outlet port of each main hydraulic pump reduces failures caused by contamination.



Metal Guard Rings

Metal guard rings protect all the hydraulic cylinders and improve reliability.

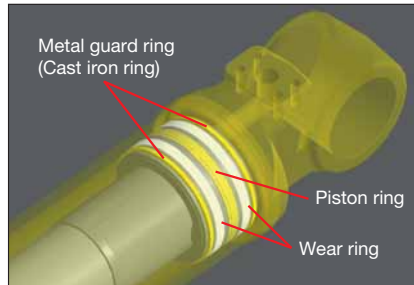

Heat-resistant Wiring

Heat-resistant wiring is utilized for the engine electric circuit and other major component circuit.

Additional Water Separator

Removes water from the fuel and improves the reliability of fuel systems.



Sturdy Undercarriage

The undercarriage is strengthened to provide excellent reliability and durability when working on rocky ground or blasted rock.



Sturdy guards shield the travel motors and piping against damage from rocks.



Track roller guard (Full length) (Optional)

Sealed Connectors

Sealed connectors seal tight and have higher reliability.

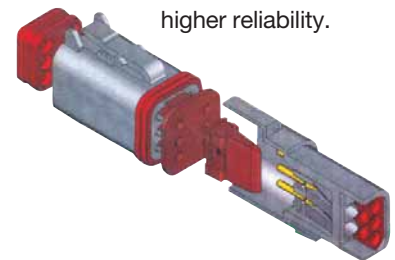

Circuit Breaker

With circuit breaker, the machine can be easily restarted after repair.



Strengthened Quarry Bucket Provides Outstanding Wear-resistance

The PC1250-8R has the bucket for specific use in quarry, this is strong in impact and wear, and providing high performance and long life. Komatsu KVV's hard materials* provide excellent wear resistance. Combined with adoption of long-life XS teeth, durability of bucket is drastically enhanced.

* Komatsu KVV's hard materials:
Komatsu KVV developed, wear-resistant, reinforced materials. Brinell hardness: 500 or more (180 kg/mm² class). Features high wear-resistance and little quality change from the heat generated during rock loading, maintaining long term hardness.

XS Tooth

- Unique bucket tooth shape for superior digging performance
- Long-term high sharpness
- Great penetration performance
- Hammerless, safe, and easy tooth replacement (Tooth replacement time: Half of the conventional machine.)

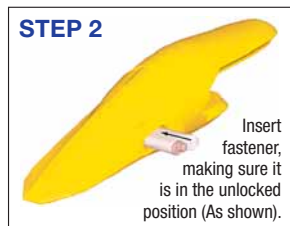
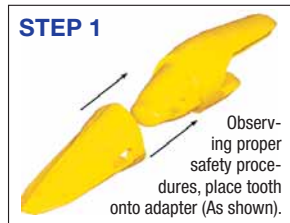
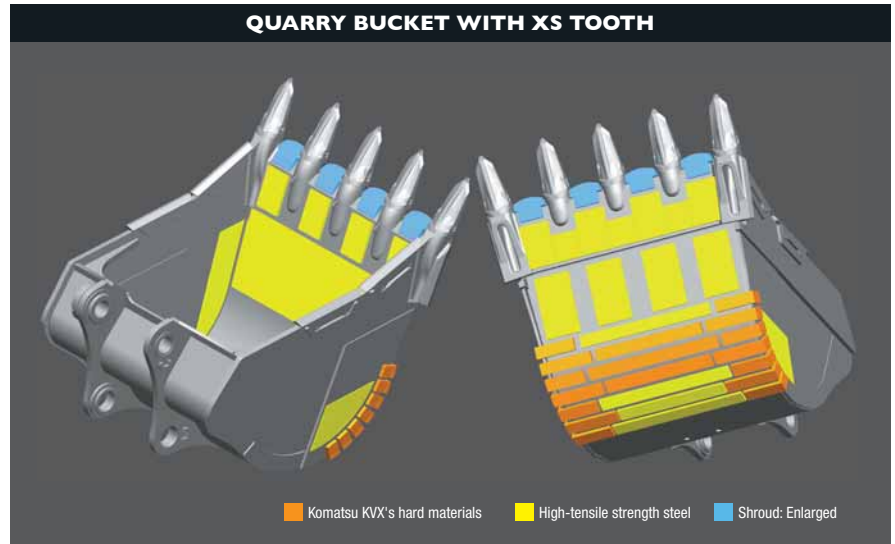

COMFORT



Photo may include optional equipment.

Wide Newly-designed Cab

Newly-designed wide spacious cab includes seat with reclining backrest. The seat height and longitudinal inclination are easily adjusted using a pull-up lever. You can set the appropriate operational position of the armrest and the console. The reclining seat further enables you to place it into the fully flat state with the headrest attached.



Seat with headrest reclined full flat

Low Noise Design Cab

The newly-designed cab is highly rigid and has excellent sound absorption. Improvements in noise source reduction combined with the use of a low noise engine, hydraulic equipment, and optional air conditioner (A/C) allows the operator to work in quiet operating condition.

Pressurized Cab

Optional A/C, air filter and a higher internal air pressure minimize external dust from entering the cab.



Photo may include optional equipment.

Low Vibration with Cab Damper Mounting

PC1250-8R uses viscous damper mounts for the cab that incorporates longer stroke and the addition of a spring. The cab damper mounting combined with high rigidity deck aids vibration reduction at the operator's seat.

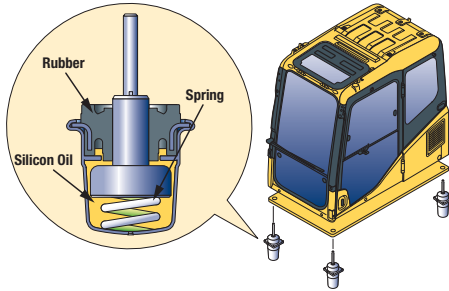

Automatic A/C (Optional)

Enables you to easily and precisely set cab atmosphere with the instruments on the LCD. The automatic A/C uses a bi-level control function that keeps the operator's head and feet cool and warm respectively.

This improved air flow function keeps the inside of the cab comfortable throughout the year. Defroster function keeps the front glass clear.

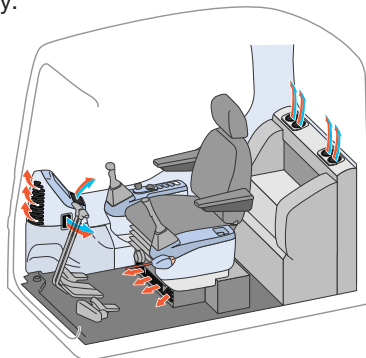

Multi-position Controls

The multi-position, Pressure Proportional Control (PPC) levers allow the operator to work in comfort while maintaining precise control. A double-slide mechanism allows the seat and control levers to move together or independently, allowing the operator to position the controls for maximum productivity and comfort.



Seat sliding amount: 340 mm increased 120 mm

Cab Equipments



Defroster (Optional)



Cab Frame Mounted Wiper



Bottle Holder and Magazine Rack

SAFETY

Step Light with Timer

provides light for about one minute to allow the operator to get off the machine safely.



Interconnected Horn and Flashing Light (Optional)

gives visual and audible notice of the excavator's operation when activated.



Slip-resistant Plates

Spiked plates on working areas provide slip-resistant performance.



Pump/Engine Room Partition

prevents oil from spraying on the engine if a hydraulic hose should burst.



Thermal and Fan Guards

are placed around high-temperature parts of the engine and fan drive.

KOMTRAX Plus (Optional)

KOMTRAX Plus system allows us to monitor the health conditions of major components and to analyze the machine. KOMTRAX Plus controller monitors and stores all data received from the controllers and various additional sensors on the major components.

This way, it's possible to record the evolution of the machine's health condition. This data can be downloaded via a portable computer or via satellite communication (Optional). In both cases, customers and Komatsu specialists can analyze this downloaded data and follow up trends in the machine's condition. When using the optional satellite communications, the Komatsu specialist can inform you whenever an abnormal condition occurs. This way, repair and maintenance costs can be optimized, and maximum machine availability can be maintained.

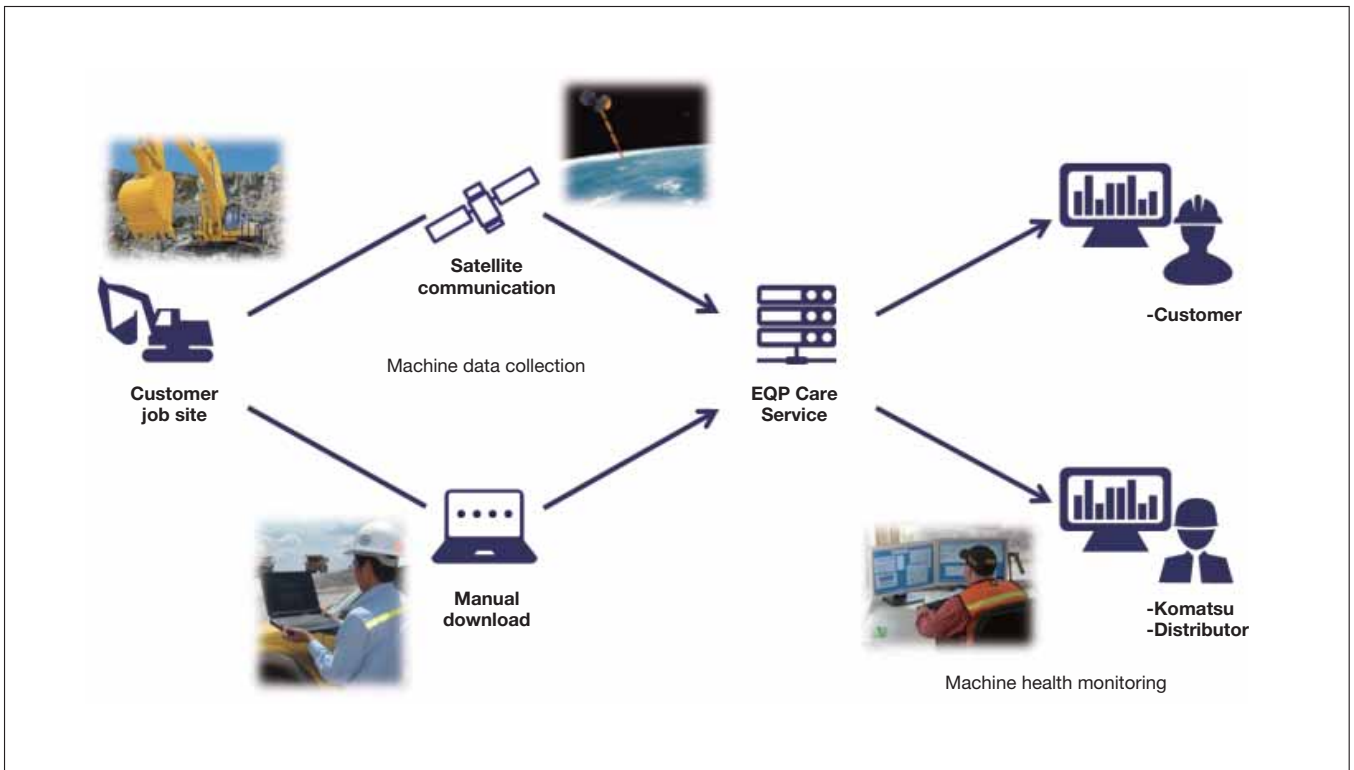

MAINTENANCE

Easy Checking and Maintenance of Engine

Wide center walkway provides easy access to many inspection and maintenance points. In addition, inspection and maintenance points are grouped to facilitate easy engine and hydraulic component checks.



One-touch Drain Cock

Easier, cleaner engine oil changes.

Easy Cleaning of Cooling Unit

Reverse-rotation function of the hydraulic driven fan simplifies cleaning out the cooling unit. In addition, this function contributes to reducing warming-up run time in low temperature and discharging hot air from the engine room to keep appropriate heat balance.



Long-life Oil, Filter

Uses high-performance filtering materials and long-life oil. Extends the oil and filter replacement interval.



Hydraulic oil filter

Engine oil & Engine oil filter	every 500 hours
Hydraulic oil	every 5000 hours
Hydraulic oil filter	every 1000 hours

Wide Catwalk

Easier, safer operator cab access and maintenance checks.



Convenient Utility Space to the Machine Cab

Utility space provides great convenience to store tools, spare parts, etc.



Washable Cab Floormat

Cab floormat is easy to keep clean. The gently inclined surface has a flanged floormat and drainage holes to facilitate runoff.



Air-operated Greasing (Optional)

Lubrication indicator confirms greasing is being performed.

- Hose reel to reach all grease points easily.
- PC1250-8R grease points are grouped for easy access, ensuring complete maintenance.



High-quality Equipment Management Monitoring System Self-diagnostic System

Abnormality checking function

If any abnormality should occur, the monitoring system checks whether hydraulic pressures, solenoid ON/OFF status, engine speed, electrical connections, etc. are within normal condition to keep machine downtime to a minimum.

Maintenance history memory function

Maintenance records such as replacement of engine oil, hydraulic oil, filters, etc. can be stored. Operator is warned when service is due.

Trouble data memory function

Trouble data is stored to serve as references for future troubleshooting. Error codes are displayed to aid in service diagnosis.

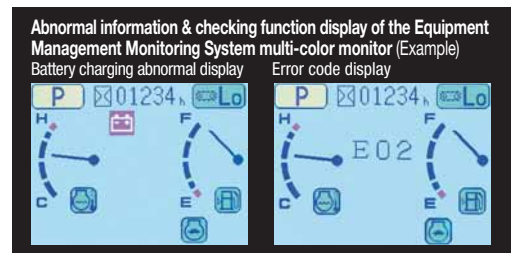
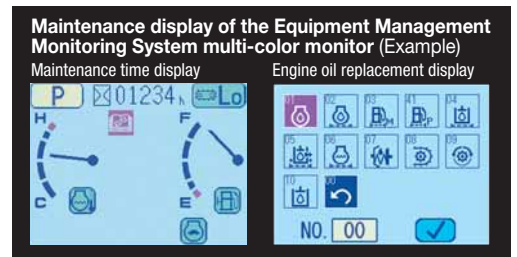

KOMATSU BRAND BUCKET

KOMATSU Brand Bucket

Me Bucket Feature

- Low resistant excavation
- High productivity
- High durability
- High fuel efficiency



Conventional



Me bucket

Category and Feature

Category	Load / Wear / Soil (Application)	Image
Heavy Duty HD	Load Machine power is high during majority of the work. Medium, but continuous shock load Wear Material is abrasive. Light scratch marks can be seen at the bucket. Soil Limestone, shot rock, compact mix of sand, gravel and clay	
General Purpose GP	Load Machine power is mostly medium, but occasionally high. Bucket movements are smooth with minor shock load. Bucket penetrates easily. Wear Material is lightly abrasive. Some sand may be medium abrasive. Soil Mostly loose sand, gravel and finely broken materials	

Bucket Line-up

Bucket Type	Capacity (m ³) (ISO 7451)	Width* ¹ (mm)	Weight* ² (kg)	Tooth Quantity	Boom + Arm (m)				Tooth Type	Photo No.
					STD			SP		
					9.1+3.4	9.1+4.5	9.1+5.7	7.8+3.4	XS	
Conventional	3.40	1670<1510>[—]	3550	4	—	▲	○	—	—	①
	4.00	1790<1880>[—]	3820	4	▲	○	□	—	—	②
	5.00	2130<2220>[—]	4370	5	○	□	—	—	—	③
	5.20	2110<2050>[2310]	5780	5	○	□	—	—	✓	④
	6.70	2300<2280>[2530]	6500	6	—	—	—	○	✓	⑤

*1 With side cutter or side shrouds, < > without side cutter or side shrouds, [] Bucket lip width *2 With sidecutters

▲ : General purpose use, density up to 2.1 t/m³ ○ : General purpose use, density up to 1.8 t/m³ □ : General purpose use, density up to 1.5 t/m³ ✓ : Selectable

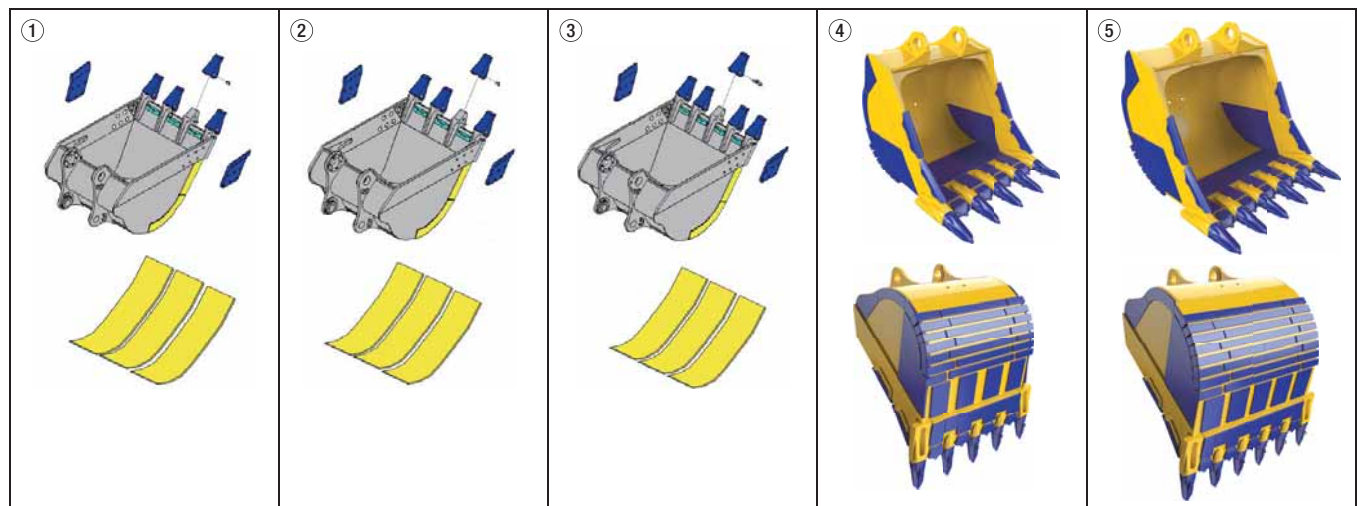

SP SPEC.

PC1250 SP spec. is equipped with a large bucket. It increases the efficiency of loading a dump truck with large amounts of loose materials such as blasted rock.



Photo may include optional equipment.

OPTIONS

- Cab front full height guard level 2 (ISO 10262)



- Interconnected horn and flashing light



- Strengthened track frame undercover

KOMATSU TOTAL SUPPORT



Komatsu Total Support

To keep your machine available and minimize operation cost when you need it, Komatsu Distributor is ready to provide a variety of supports before and after procuring the machine.

Fleet recommendation

Komatsu Distributor can study the customer's job site and provide the most optimum fleet recommendation with detailed information to meet all of your application needs when you are considering to buy new machines or replace the existing ones from Komatsu.



Product support

Komatsu Distributor gives the proactive support and secures the quality of the machinery that will be delivered.

Parts availability

Komatsu Distributor is available for emergency inquiry by the customers for genuine, quality guaranteed Komatsu parts.

Technical support

Komatsu product support service (Technical support) is designed to help customer. Komatsu Distributor offers a variety of effective services to show how much Komatsu is dedicated to the maintenance and support of Komatsu machine.

- Preventive Maintenance (PM) clinic
- Oil & Wear analysis program
- Undercarriage inspection service, etc.

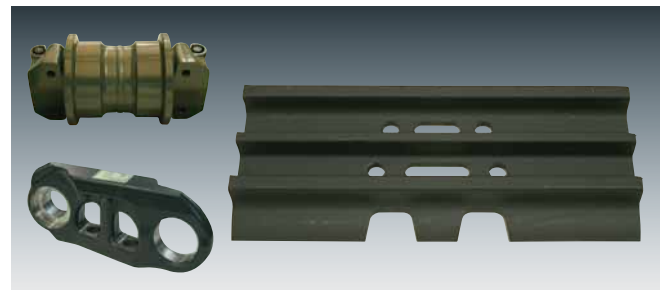

Repair & maintenance service

Komatsu Distributor offers quality repair and maintenance service to the customer, utilizing and promoting Komatsu developed programs.

Komatsu Reman (Remanufactured) components

Komatsu Reman products are the result of the implementation of the Komatsu global policy which establishes and agrees to reduce the owning, operating and total Life Cycle Costs (LCC) to Komatsu's customer through high quality, prompt delivery and competitively priced in own remanufactured products (QDC).



SPECIFICATIONS



ENGINE

Model Komatsu SAA6D170E-5
 Type 4-cycle, water-cooled, direct injection
 Aspiration Turbocharged, aftercooled, cooled EGR
 Number of cylinders 6
 Bore 170 mm
 Stroke 170 mm
 Piston displacement 23.15 L
 Governor All-speed, electronic
 Horsepower:
 SAE J1995 Gross 514 kW 688 HP
 ISO 9249 / SAE J1349* Net 502 kW 672 HP
 Rated rpm 1800 min⁻¹
 Fan drive type Hydraulic

* Net horsepower at the maximum speed of radiator cooling fan is 463 kW 620HP.



HYDRAULIC SYSTEM

Type Open-center load-sensing system
 Number of selectable working modes 2
 Main pump:
 Type Variable-capacity piston pumps
 Pumps for Boom, arm, bucket, swing, and travel circuits
 Maximum flow:
 For implement and travel 2 x 494 L/min
 For swing 1 x 600 L/min
 Sub-pump for control circuit Gear pump
 Hydraulic motors:
 Travel 2 x axial piston motors with parking brake
 Swing 2 x axial piston motors with swing holding brake
 Relief valve setting:
 Implement circuits
 Backhoe 31.4 MPa 320 kgf/cm²
 Loading shovel 31.4 MPa 320 kgf/cm²
 Travel circuit 34.3 MPa 350 kgf/cm²
 Swing circuit 27.5 MPa 280 kgf/cm²
 Pilot circuit 2.9 MPa 30 kgf/cm²
 Hydraulic cylinders:
 Number of cylinders—bore x stroke
 Backhoe
 Boom 2 – 225 mm x 2390 mm
 Arm 1 – 250 mm x 2435 mm
 Bucket
 Std 2 – 160 mm x 1825 mm
 SP 2 – 160 mm x 1950 mm
 Loading shovel
 Boom 2 – 225 mm x 1960 mm
 Arm 2 – 185 mm x 1765 mm
 Bucket 2 – 200 mm x 1700 mm
 Bottom dump 2 – 160 mm x 435 mm



SWING SYSTEM

Driven by Hydraulic motors
 Swing reduction Planetary gear
 Swing circle lubrication Grease-bathed
 Swing lock Oil disc brake
 Swing speed 5.8 min⁻¹



DRIVES AND BRAKES

Steering control Two levers with pedals
 Drive method Fully hydrostatic
 Travel motor Axial piston motor, in-shoe design
 Reduction system Planetary double reduction
 Maximum drawbar pull 686 kN 70000 kgf
 Gradeability 70%
 Maximum travel speed
 Low 2.1 km/h
 High 3.2 km/h
 Service brake Hydraulic lock



UNDERCARRIAGE

Center frame H-leg frame
 Track frame Box-section
 Seal of track Sealed
 Track adjuster Hydraulic
 No. of shoes (Each side) 48
 No. of carrier rollers (Each side) 3
 No. of track rollers (Each side) 8



COOLANT AND LUBRICANT CAPACITY (REFILLING)

Fuel tank 1360 L
 Radiator 142 L
 Engine 86 L
 Final drive (Each side) 21 L
 Swing drive 20 x 2 L
 Hydraulic tank 670 L
 Power Take Off (PTO) 13.5 L



OPERATING WEIGHT (APPROXIMATE)

BACKHOE
 PC1250-8R: Operating weight including 9100 mm boom, 3400 mm arm, ISO 7451 heaped 5.00 m³ backhoe bucket, operator, lubricants, coolant, full fuel tank, and standard equipment.
 PC1250SP-8R: Operating weight including 7800 mm boom, 3400 mm arm, ISO 7451 heaped 6.70 m³ backhoe bucket, full length roller guard, operator, lubricants, coolant, full fuel tank, and standard equipment.

Shoes	PC1250-8R		PC1250SP-8R	
	Operating Weight	Ground Pressure	Operating Weight	Ground Pressure
Double Grouser 700 mm	113500 kg	144 kPa 1.47 kgf/cm ²	116600 kg	149 kPa 1.52 kgf/cm ²
Double Grouser 1000 mm	115800 kg	103 kPa 1.05 kgf/cm ²	—	—

LOADING SHOVEL
 Operating weight including 5300 mm boom, 3800 mm arm, ISO 7451 heaped 6.50 m³ bucket, operator, lubricants, coolant, full fuel tank, and standard equipment.

Shoes	PC1250-8R	
	Operating Weight	Ground Pressure
Double Grouser 700 mm	116800 kg	148.7 kPa 1.52 kgf/cm ²



BACKHOE DIMENSIONS

Unit: mm

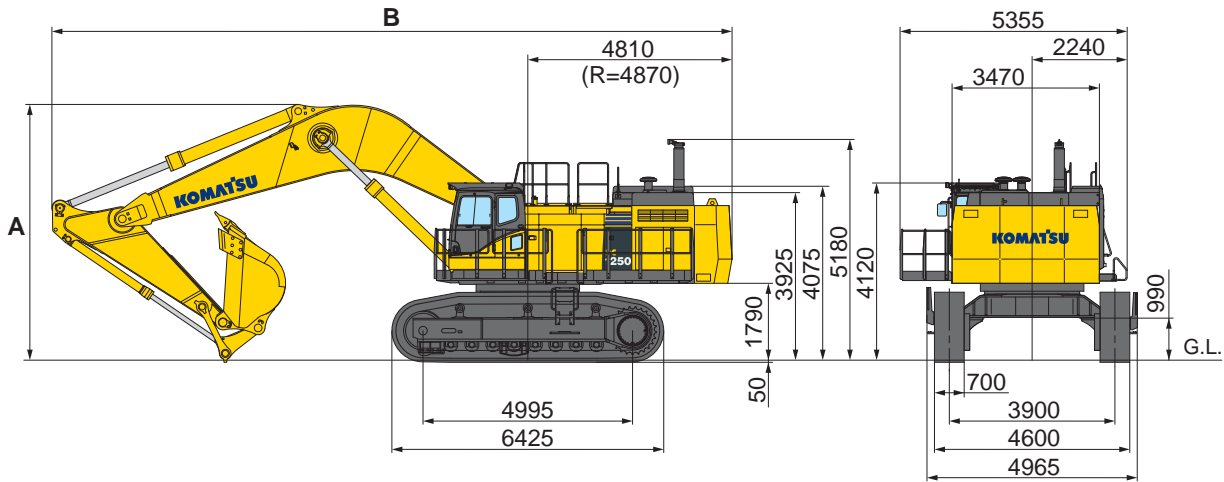

Model	PC1250-8R			PC1250SP-8R
Boom Length	9100 mm			7800 mm
Arm Length	3400 mm	4500 mm	5700 mm	3400 mm
A Overall height	6040 mm	6460 mm	6990 mm	6265 mm
B Overall length	16020 mm	16050 mm	15840 mm	14790 mm



BACKHOE WORKING RANGE

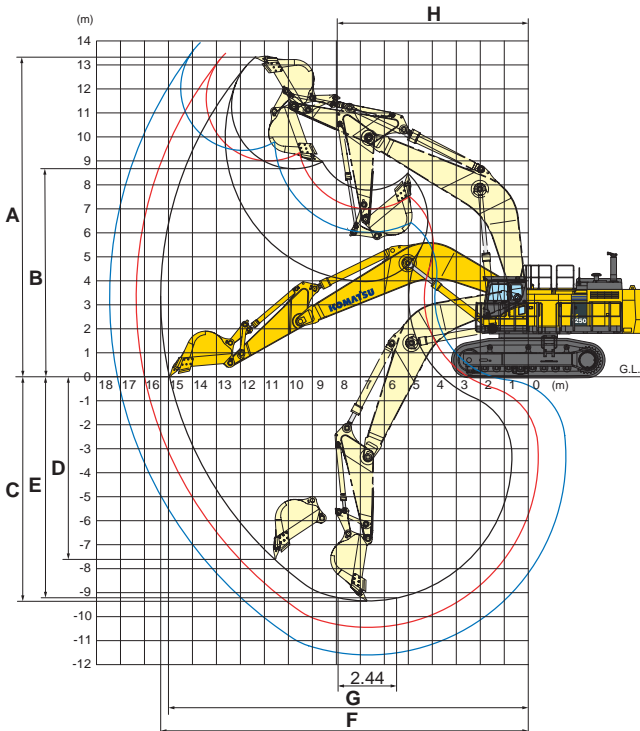

Model	PC1250-8R			PC1250SP-8R
Boom Length	9100 mm			7800 mm
Arm Length	3400 mm	4500 mm	5700 mm	3400 mm
A Max. digging height	13400 mm	13490 mm	13910 mm	13000 mm
B Max. dumping height	8680 mm	9000 mm	9440 mm	8450 mm
C Max. digging depth	9350 mm	10440 mm	11590 mm	7900 mm
D Max. vertical wall digging depth	7610 mm	8490 mm	9480 mm	5025 mm
E Max. digging depth of cut for 2440 mm level	9220 mm	10340 mm	11500 mm	7745 mm
F Max. digging reach	15350 mm	16340 mm	17450 mm	14070 mm
G Max. digging reach at ground level	15000 mm	16000 mm	17130 mm	13670 mm
H Min. swing radius	7965 mm	7990 mm	8150 mm	6415 mm
SAE J 1179 Rating	Bucket digging force	422 kN 43000 kgf	422 kN 43000 kgf	343 kN 35000 kgf
	Arm crowd force	392 kN 40000 kgf	327 kN 33300 kgf	281 kN 28700 kgf
ISO 6015 Rating	Bucket digging force	479 kN 48800 kgf	479 kN 48800 kgf	389 kN 39700 kgf
	Arm crowd force	412 kN 42000 kgf	337 kN 34400 kgf	286 kN 29200 kgf

— : PC1250-8R 9100 mm boom, 5700 mm arm
 — : PC1250-8R 9100 mm boom, 4500 mm arm
 — : PC1250-8R 9100 mm boom, 3400 mm arm



LOADING SHOVEL DIMENSIONS

Unit: mm

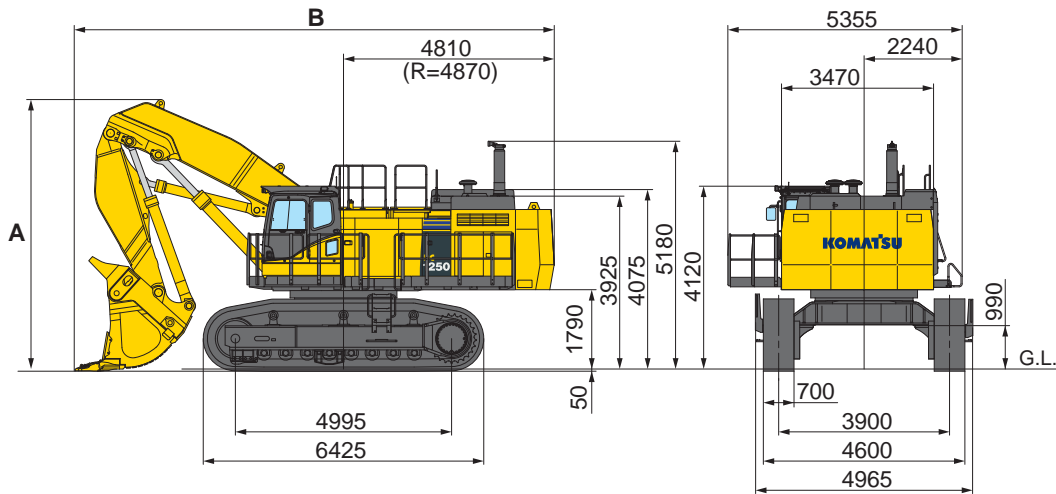

Type of Bucket	Bottom Dump
Capacity-heaped	6.50 m ³
A Overall height	6200 mm
B Overall length	10940 mm



LOADING SHOVEL WORKING RANGE AND BUCKET SELECTION

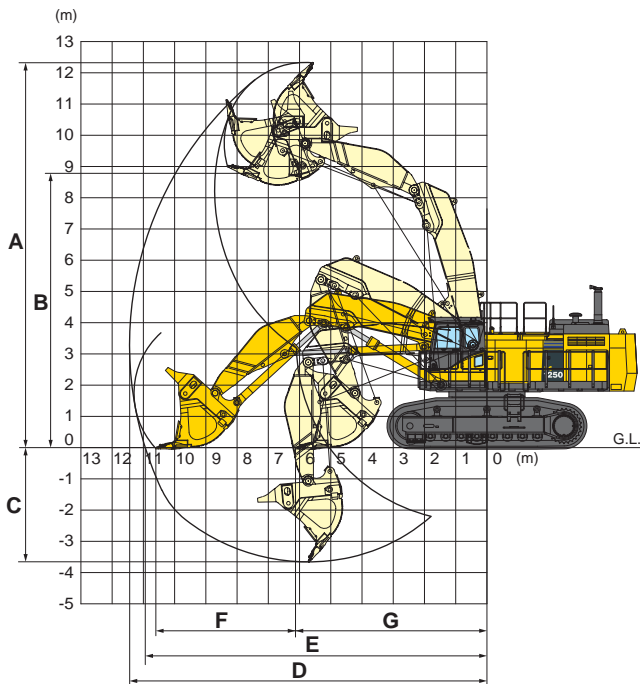

Type of Bucket	Bottom Dump
Capacity-heaped	6.50 m ³
A Max. cutting height	12330 mm
B Max. dumping height	8700 mm
C Max. digging depth	3650 mm
D Max. digging reach	11400 mm
E Max. digging reach at ground level	10900 mm
F Level crowding distance	4480 mm
G Min. crowd distance	6130 mm
Bucket digging force	579 kN 59000 kgf
Arm crowd force	608 kN 62000 kgf

Bucket Selection

Type of Bucket	Bottom Dump	
Capacity-heaped	6.50 m ³	7.20 m ³
Width (With Side Shrouds)	2700 mm	2700 mm
Weight	9730 kg	9750 kg
No. of Bucket Teeth	6	6
Recommended Uses	General-purpose digging and loading	Light-duty excavation and loading



LIFTING CAPACITY

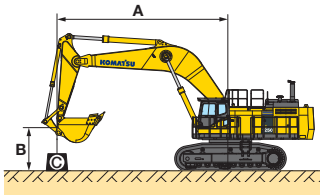

PC1250-8R

- A: Reach from swing center
- B: Bucket hook height
- C: Lifting capacity
- Cf: Rating over front
- Cs: Rating over side
- ⊗: Rating at maximum reach

HEAVY LIFT "ON"

PC1250-8R		Boom: 9100 mm		Arm: 3400 mm		Bucket: 5.00 m ³ ISO 7451 heaped		Bucket weight: 4400 kg		Shoe: 700 mm double grouser					
B	A	⊗ MAX		12.2 m		10.7 m		9.1 m		7.6 m		6.1 m		4.6 m	
		Cf	Cs	Cf	Cs	Cf	Cs	Cf	Cs	Cf	Cs	Cf	Cs	Cf	Cs
9.1 m		*15200 kg	*15200 kg			*18000 kg	*18000 kg								
6.1 m		*15950 kg	13200 kg			*20050 kg	17400 kg	*22950 kg	*22950 kg	*27900 kg	*27900 kg				
3.0 m		15650 kg	11850 kg	16400 kg	12500 kg	20850 kg	16100 kg	27000 kg	20850 kg	*34950 kg	27650 kg				
0.0 m		16250 kg	12300 kg			19950 kg	15200 kg	24200 kg	18200 kg	34400 kg	26100 kg				
-3.0 m		19950 kg	15250 kg			20000 kg	15250 kg	25600 kg	19550 kg	34600 kg	26300 kg	*43850 kg	38400 kg	*39250 kg	*39250 kg
-6.1 m		*23500 kg	*23500 kg							*25400 kg	*25400 kg	*32550 kg	*32550 kg		

HEAVY LIFT "OFF"

PC1250-8R		Boom: 9100 mm		Arm: 3400 mm		Bucket: 5.00 m ³ ISO 7451 heaped		Bucket weight: 4400 kg		Shoe: 700 mm double grouser					
B	A	⊗ MAX		12.2 m		10.7 m		9.1 m		7.6 m		6.1 m		4.6 m	
		Cf	Cs	Cf	Cs	Cf	Cs	Cf	Cs	Cf	Cs	Cf	Cs	Cf	Cs
9.1 m		*15200 kg	*15200 kg			*15500 kg	*15500 kg								
6.1 m		*15850 kg	13200 kg			*17300 kg	*17300 kg	*19950 kg	*19950 kg	*24400 kg	*24400 kg				
3.0 m		15650 kg	11850 kg	16400 kg	12500 kg	*19800 kg	16100 kg	*23900 kg	20850 kg	*30550 kg	27650 kg				
0.0 m		16250 kg	12300 kg			19950 kg	15200 kg	24200 kg	18200 kg	*32650 kg	26100 kg				
-3.0 m		*19600 kg	15250 kg			*19650 kg	15250 kg	*24750 kg	19550 kg	*30750 kg	26300 kg	*38350 kg	*38350 kg	*39250 kg	*39250 kg
-6.1 m		*20150 kg	*20150 kg							*21900 kg	*21900 kg	*28150 kg	*28150 kg		

* Load is limited by hydraulic capacity rather than tipping. Ratings are based on SAE J1097. Rated loads do not exceed 87% of hydraulic lift capacity or 75% of tipping load.

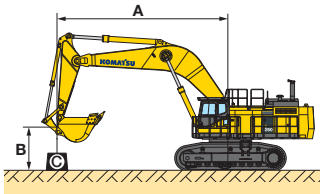

PC1250-8R

- A: Reach from swing center
- B: Bucket hook height
- C: Lifting capacity
- Cf: Rating over front
- Cs: Rating over side
- ⊗: Rating at maximum reach

HEAVY LIFT "ON"

PC1250-8R		Boom: 9100 mm		Arm: 4500 mm		Bucket: 4.00 m ³ ISO 7451 heaped		Bucket weight: 3800 kg		Shoe: 700 mm double grouser					
B	A	⊗ MAX		12.2 m		10.7 m		9.1 m		7.6 m		6.1 m		4.6 m	
		Cf	Cs	Cf	Cs	Cf	Cs	Cf	Cs	Cf	Cs	Cf	Cs	Cf	Cs
9.1 m		*9300 kg	*9300 kg												
6.1 m		*9650 kg	*9650 kg	*16650 kg	13700 kg	*18150 kg	18000 kg	*20550 kg	*20550 kg						
3.0 m		*10950 kg	10200 kg	16650 kg	12750 kg	21200 kg	16400 kg	*25600 kg	21300 kg	*32350 kg	28500 kg				
0.0 m		*13650 kg	10400 kg	15850 kg	11950 kg	19900 kg	15150 kg	24550 kg	18500 kg	34450 kg	26100 kg	*29300 kg	*29300 kg		
-3.0 m		16400 kg	12400 kg			19550 kg	14800 kg	25100 kg	19050 kg	34000 kg	25700 kg	*46350 kg	37500 kg	*31900 kg	*31900 kg
-6.1 m		*21750 kg	18700 kg					*23650 kg	20000 kg	*28850 kg	25200 kg	*38200 kg	*38200 kg	*48900 kg	*48900 kg

HEAVY LIFT "OFF"

PC1250-8R		Boom: 9100 mm		Arm: 4500 mm		Bucket: 4.00 m ³ ISO 7451 heaped		Bucket weight: 3800 kg		Shoe: 700 mm double grouser					
B	A	⊗ MAX		12.2 m		10.7 m		9.1 m		7.6 m		6.1 m		4.6 m	
		Cf	Cs	Cf	Cs	Cf	Cs	Cf	Cs	Cf	Cs	Cf	Cs	Cf	Cs
9.1 m		*9300 kg	*9300 kg												
6.1 m		*9650 kg	*9650 kg	*14250 kg	13700 kg	*15600 kg	*15600 kg	*17850 kg	*17850 kg						
3.0 m		*10950 kg	10200 kg	*16050 kg	12750 kg	*18500 kg	16400 kg	*22250 kg	21300 kg	*28250 kg	*28250 kg				
0.0 m		*13650 kg	10400 kg	15850 kg	11950 kg	19900 kg	15150 kg	*24200 kg	18500 kg	*31950 kg	26100 kg	*29300 kg	*29300 kg		
-3.0 m		16400 kg	12400 kg			19550 kg	14800 kg	25100 kg	19050 kg	*31650 kg	25700 kg	*40550 kg	37500 kg	*31900 kg	*31900 kg
-6.1 m		*18650 kg	18650 kg					*20300 kg	20000 kg	*24800 kg	24800 kg	*33200 kg	*33200 kg	*42600 kg	*42600 kg

* Load is limited by hydraulic capacity rather than tipping. Ratings are based on SAE J1097. Rated loads do not exceed 87% of hydraulic lift capacity or 75% of tipping load.



LIFTING CAPACITY

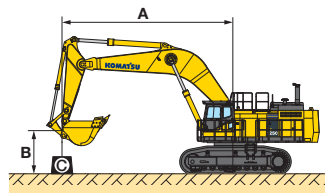

PC1250-8R

- A: Reach from swing center
- B: Bucket hook height
- C: Lifting capacity
- Cf: Rating over front
- Cs: Rating over side
- ⊗: Rating at maximum reach

HEAVY LIFT "ON"

PC1250-8R		Boom: 9100 mm		Arm: 5700 mm		Bucket: 3.40 m ³ ISO 7451 heaped		Bucket weight: 3600 kg		Shoe: 700 mm double grouser					
B	A	⊗ MAX		13.7 m		12.2 m		10.7 m		9.1 m		7.6 m		6.1 m	
		Cf	Cs	Cf	Cs	Cf	Cs	Cf	Cs	Cf	Cs	Cf	Cs	Cf	Cs
9.1 m		*5900 kg	*5900 kg												
6.1 m		*6050 kg	*6050 kg	*11050 kg	10950 kg	*14950 kg	14350 kg								
3.0 m		*6800 kg	*6800 kg	13550 kg	10250 kg	17050 kg	13100 kg	*19800 kg	16900 kg	*23450 kg	22050 kg	*29300 kg	*29300 kg	*39750 kg	*39750 kg
0.0 m		*8400 kg	*8400 kg	12850 kg	9600 kg	15950 kg	12050 kg	20100 kg	15300 kg	25900 kg	19800 kg	34800 kg	26450 kg	*31200 kg	*31200 kg
-3.0 m		*11500 kg	10150 kg			15500 kg	11600 kg	19300 kg	14600 kg	24850 kg	18800 kg	33600 kg	25300 kg	*47600 kg	36800 kg
-6.1 m		18600 kg	14100 kg					19750 kg	15000 kg	25200 kg	19150 kg	*33250 kg	25850 kg	*42350 kg	37850 kg

HEAVY LIFT "OFF"

PC1250-8R		Boom: 9100 mm		Arm: 5700 mm		Bucket: 3.40 m ³ ISO 7451 heaped		Bucket weight: 3600 kg		Shoe: 700 mm double grouser					
B	A	⊗ MAX		13.7 m		12.2 m		10.7 m		9.1 m		7.6 m		6.1 m	
		Cf	Cs	Cf	Cs	Cf	Cs	Cf	Cs	Cf	Cs	Cf	Cs	Cf	Cs
9.1 m		*5900 kg	*5900 kg												
6.1 m		*6050 kg	*6050 kg	*11050 kg	10950 kg	*12700 kg	*12700 kg								
3.0 m		*6800 kg	*6800 kg	*13350 kg	10250 kg	*14850 kg	13100 kg	*17050 kg	16900 kg	*20300 kg	*20300 kg	*25550 kg	*25550 kg	*34850 kg	*34850 kg
0.0 m		*8400 kg	*8400 kg	12850 kg	9600 kg	15950 kg	12050 kg	*19700 kg	15300 kg	*24000 kg	19800 kg	*30600 kg	26450 kg	*31200 kg	*31200 kg
-3.0 m		*11500 kg	10150 kg			15500 kg	11600 kg	19300 kg	14600 kg	24850 kg	18800 kg	*31900 kg	25300 kg	*41650 kg	36600 kg
-6.1 m		*16550 kg	14100 kg					*18050 kg	15000 kg	*22950 kg	19150 kg	*28850 kg	25850 kg	*36900 kg	*36900 kg

* Load is limited by hydraulic capacity rather than tipping. Ratings are based on SAE J1097. Rated loads do not exceed 87% of hydraulic lift capacity or 75% of tipping load.

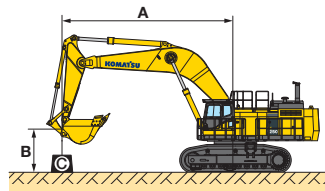

PC1250SP-8R

- A: Reach from swing center
- B: Bucket hook height
- C: Lifting capacity
- Cf: Rating over front
- Cs: Rating over side
- ⊗: Rating at maximum reach

HEAVY LIFT "ON"

PC1250SP-8R		Boom: 7800 mm		Arm: 3400 mm		Bucket: 6.70 m ³ ISO 7451 heaped		Bucket weight: 6500 kg		Shoe: 700 mm double grouser					
B	A	⊗ MAX		12.2 m		10.7 m		9.1 m		7.6 m		6.1 m		4.6 m	
		Cf	Cs	Cf	Cs	Cf	Cs	Cf	Cs	Cf	Cs	Cf	Cs	Cf	Cs
9.1 m		*11700 kg	*11700 kg					*17050 kg	*17050 kg						
6.1 m		*12250 kg	*12250 kg			*16300 kg	16100 kg	*24350 kg	22600 kg	*28750 kg	*28750 kg	*36350 kg	*36350 kg		
3.0 m		*14600 kg	13700 kg			20150 kg	15300 kg	26950 kg	20750 kg	*33850 kg	27000 kg	*47450 kg	41150 kg		
0.0 m		19300 kg	14550 kg			19400 kg	14600 kg	25600 kg	19450 kg	31750 kg	23500 kg	*48750 kg	38650 kg		
-3.0 m		*23900 kg	19550 kg					*23950 kg	19550 kg	*30750 kg	24850 kg	*41450 kg	39250 kg	*52450 kg	*52450 kg
-6.1 m															

HEAVY LIFT "OFF"

PC1250SP-8R		Boom: 7800 mm		Arm: 3400 mm		Bucket: 6.70 m ³ ISO 7451 heaped		Bucket weight: 6500 kg		Shoe: 700 mm double grouser					
B	A	⊗ MAX		12.2 m		10.7 m		9.1 m		7.6 m		6.1 m		4.6 m	
		Cf	Cs	Cf	Cs	Cf	Cs	Cf	Cs	Cf	Cs	Cf	Cs	Cf	Cs
9.1 m		*11700 kg	*11700 kg					*17050 kg	*17050 kg						
6.1 m		*12250 kg	*12250 kg			*16300 kg	16100 kg	*21150 kg	*21150 kg	*25150 kg	*25150 kg	*32100 kg	*32100 kg		
3.0 m		*14600 kg	13700 kg			20150 kg	15300 kg	*24450 kg	20750 kg	*29450 kg	27000 kg	*41750 kg	41150 kg		
0.0 m		19300 kg	14550 kg			19400 kg	14600 kg	25600 kg	19450 kg	*29900 kg	23500 kg	*42750 kg	38650 kg		
-3.0 m		*20500 kg	19550 kg					*20550 kg	19550 kg	*26450 kg	24850 kg	*36100 kg	*36100 kg	*45800 kg	*45800 kg
-6.1 m															

* Load is limited by hydraulic capacity rather than tipping. Ratings are based on SAE J1097. Rated loads do not exceed 87% of hydraulic lift capacity or 75% of tipping load.



TRANSPORTATION GUIDE

Transportation volume (length x height x width)

Specs shown include the following equipment:

Backhoe: boom 9100 mm, arm 3400 mm, bucket 5.00 m³, shoes 700 mm double grouser

Work equipment assembly (Backhoe)

Weight : PC1250-8R : 25.6 t

PC1250SP-8R : 27.9 t

Boom



PC1250-8R : 11.2 t : 9475 x 2894 x 1474 mm

PC1250SP-8R : 11.1 t : 8170 x 3095 x 1474 mm

Arm

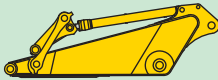

PC1250-8R : 5.9 t : 4895 x 1626 x 890 mm

6.2 t : 4895 x 1626 x 890 mm (Heavy-duty version)

PC1250SP-8R : 6.4 t : 4914 x 1683 x 890 mm

Bucket

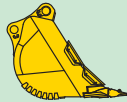

PC1250-8R : 4.4 t : 2700 x 2100 x 2050 mm

5.8 t : 2580 x 2276 x 2250 mm (Heavy-duty version)

PC1250SP-8R : 6.5 t : 2527 x 2420 x 2520 mm

Arm cylinder



Weight : 1.5 t Length : 3950 mm

Boom cylinder



Weight : 2.4 t [1.2 t x 2] Length: 3810 mm

Upper structure

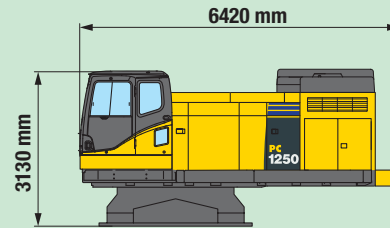

Width : 3490 mm

Weight : 36.8 t

Undercarriage

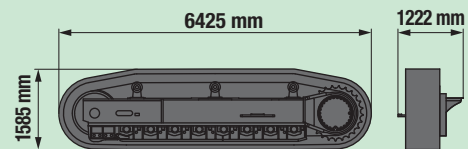

Weight : 30 t [15 t x 2]

Weight : 30.9 t [15.45 t x 2] (With full length roller guard)

Others

Weight : 18.5 t

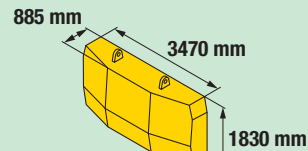

Weight : 18.0 t

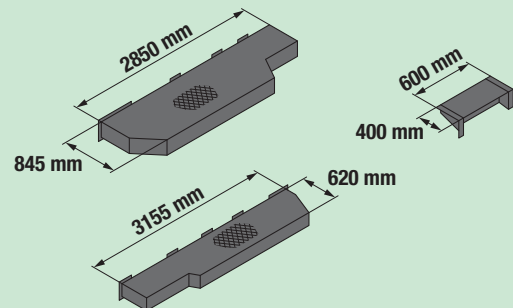
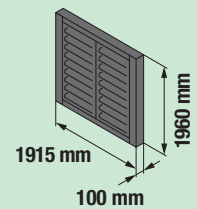

**STANDARD EQUIPMENT****ENGINE AND RELATED ITEMS:**

- Air cleaner, double element, dry
- Engine, Komatsu SAA6D170E-5
- Variable speed cooling fan, with fan guard

ELECTRICAL SYSTEM:

- Alternator, 24 V/60 A
- Auto decelerator
- Batteries, 2 x 12 V/ 220 Ah
- Starting motors, 2 x 11 kW
- Working lights: 2 on boom, 1 at right front, 2 on cab, 1 cab L.H. (Step light with timer)

UNDERCARRIAGE:

- 8 track/3 carrier rollers (Each side)
- Hydraulic track adjusters (Each side)
- Rock protectors
- Sealed track
- Track guiding guard (Each side)
- Track shoe:
 - 700 mm double grouser

GUARDS AND COVERS:

- Dust-proof net for radiator and oil cooler
- OPG top guard level 2 (ISO 10262)
- Pump/engine room partition wall
- Revolving frame under cover (Heavy-duty)
- Travel motor guards

OPERATOR ENVIRONMENT:

- Cab with fixed front window
- Damper mount, all-weather, sound-suppressed cab with tinted safety glass windows, lockable door, intermittent window wiper and washer, floor mat, cigarette lighter and ashtray

- Instrument panel with electronic display/monitor system, electronically-controlled throttle dial, electric service meter, gauges (Coolant temperature, hydraulic oil temperature and fuel level), caution lights (Electric charge, engine oil pressure, and air cleaner clogging), indicator lights (Engine preheating and swing lock light) level check lights (Coolant, engine oil, and hydraulic oil level), self-diagnostic system with trouble data memory
- Rear view mirror (R.H. and L.H.)
- Seat, fully adjustable with suspension

HYDRAULIC CONTROLS:

- Control levers and pedals for steering and travel with Pressure Proportional Control (PPC) system
- Control levers, wrist control levers for arm, boom, bucket, and swing with PPC system
- Fully hydraulic, with Electronic Open-Center Load-Sensing and engine speed sensing (Pump and engine mutual control system)
- In-line high pressure filters
- Oil cooler
- One axial piston motor per track for travel with counter balance valve
- One gear pump for control circuit
- Shockless boom control
- Three control valves, 5+4+4 spools (Boom, arm, bucket, swing, and travel)
- Three variable capacity piston pumps (2 main, 1 swing)
- Two axial piston motors for swing with single-stage relief valve
- Two-mode settings for boom

DRIVE AND BRAKE SYSTEM:

- Brakes, hydraulic lock travel brakes, oil disc parking
- Hydrostatic two travel speed system with planetary double reduction final drive

OTHER STANDARD EQUIPMENT:

- Automatic swing holding brake
- Counterweight, 18000 kg
- Horn, air
- Large handrails
- Marks and plates, English
- One-touch engine oil drainage
- Paint, Komatsu standard
- Preventive Maintenance (PM) tune-up service connector
- Rear reflector
- Slip-resistant plates
- Travel alarm
- Vandalism protection locks
- Water separator
- Wide catwalk

**OPTIONAL EQUIPMENT**

- Alternator, 24 V/90 A
- Arms (Backhoe):
 - 3400 mm arm assembly
 - 3400 mm HD arm assembly
 - 3400 mm SP arm assembly
 - 4500 mm arm assembly
 - 4500 mm HD arm assembly
 - 5700 mm arm assembly
- Arms (Loading shovel):
 - 3800 mm arm assembly
- Auto A/C

- Automatic grease system, Lincoln 18 L
- Booms (Backhoe):
 - 7800 mm SP boom assembly
 - 9100 mm boom assembly
- Booms (Loading shovel):
 - 5300 mm boom assembly
- Cab front guard level 2 (ISO 10262)
- Cab with pull-up type front window
- Communication system for KOMTRAX Plus (Orbcomm)
- Coolant heater

- General tool kit
- Grease gun, air pump
- Interconnected horn and flashing light
- KOMTRAX Plus
- Radio AM/FM
- Seat belt 78 mm
- Spare parts for first service
- Track frame undercover (Center)
- Track roller guard (Full length)
- Track shoe:
 - 1000 mm double grouser

