

KOMATSU[®]

PC130-8

PC
130

HORSEPOWER

Gross: 72.1 kW 96.6 HP / 2200 min⁻¹

Net: 68.4 kW 91.7 HP / 2200 min⁻¹

OPERATING WEIGHT

12380 – 12740 kg

BUCKET CAPACITY

0.18 – 0.60 m³



Photos may include optional equipment.

WALK-AROUND



Photos may include optional equipment.



ECOLOGY & ECONOMY

- ▮ Low Emission Engine Is U.S. EPA Tier 3 and EU Stage 3A Emissions Certified.
- ▮ Low Operation Noise

COMFORT & SAFETY

- ▮ ROPS Cab (ISO 12117-2)
- ▮ Low-noise Cab
- ▮ Wide Spacious Cab
- ▮ Rear View Monitor System (Optional)

* Information and Communication Technology

ICT* & KOMTRAX

- ▮ Large Liquid Crystal Display (LCD) Monitor
- ▮ Equipment Management Support
- ▮ KOMTRAX

RELIABILITY & DURABILITY

- ▮ High Rigidity Work Equipment
- ▮ Reliable Komatsu Manufactured Major Components

MAINTENANCE

- ▮ Easy Maintenance
- ▮ Long-life Oil and Filter

PC130-8

HORSEPOWER	Gross:	72.1 kW 96.6 HP / 2200 min ⁻¹
	Net:	68.4 kW 91.7 HP / 2200 min ⁻¹

OPERATING WEIGHT	12380 – 12740 kg
-------------------------	------------------

BUCKET CAPACITY	0.18 – 0.60 m ³
------------------------	----------------------------



ECOLOGY, ECONOMY & PRODUCTIVITY

Komatsu Technology

Komatsu develops and produces all major components in house such as engines, electronics and hydraulic components. Combining “Komatsu Technology” and customer feedback, Komatsu is achieving great advancements in technology. To achieve both high levels of productivity and economical performance, Komatsu has developed the main components with a total control system. The result is a new generation of high performance and environment-friendly excavators.

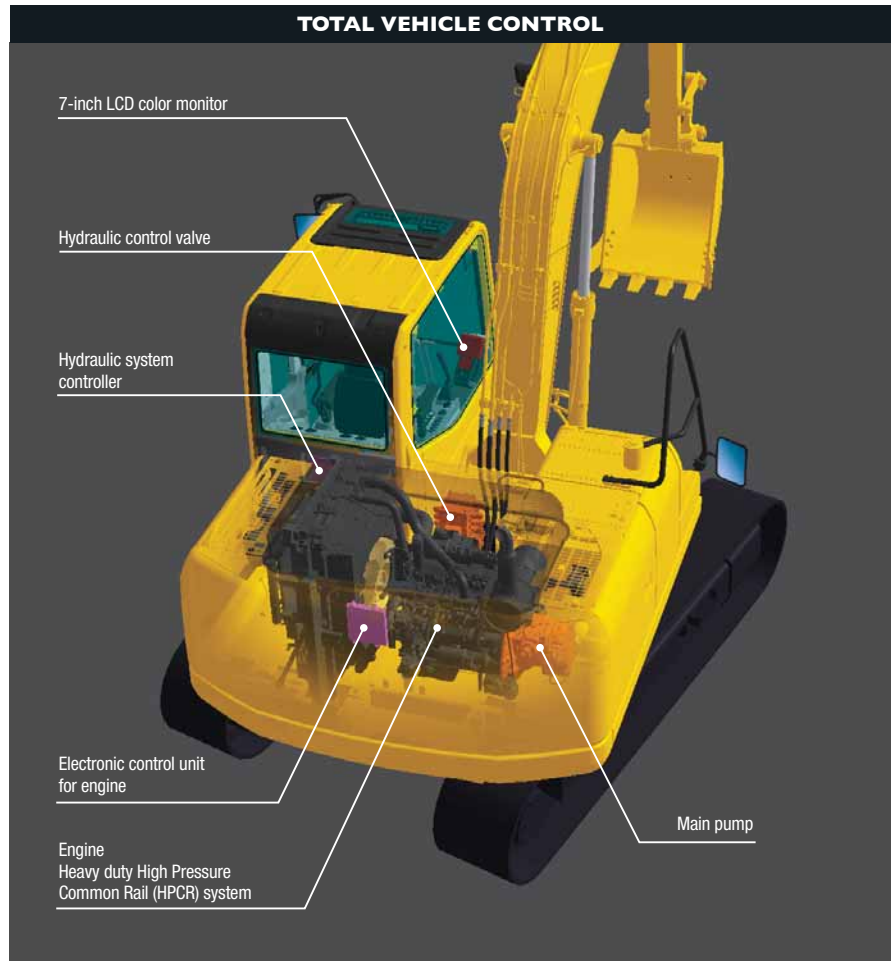

Low Emission Engine

Komatsu SAA4D95LE-5 is U.S. EPA Tier 3 and EU Stage 3A emissions certified.

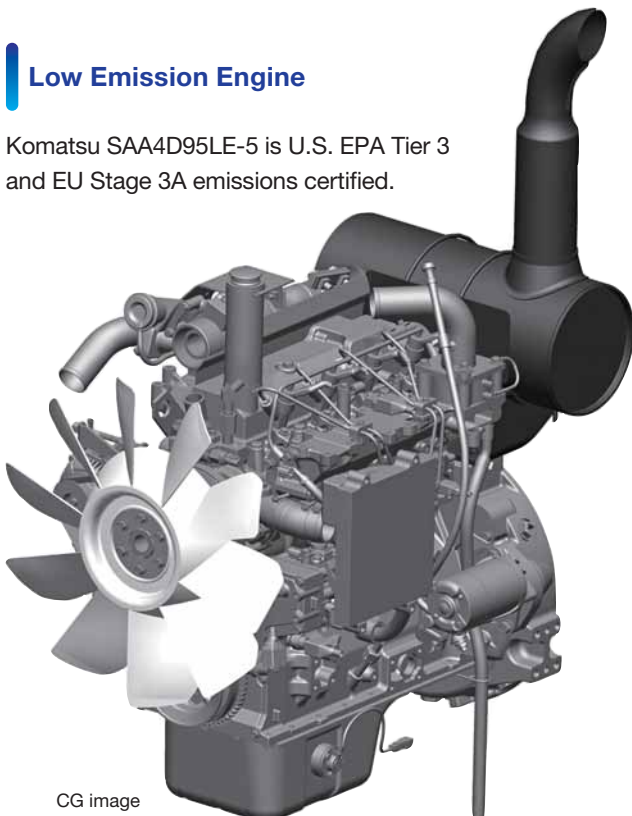

Low Operation Noise

Enables low noise operation using the low-noise engine and methods to cut noise at source.

Electronically controlled common rail type engine

- Multi-staged injection

Low noise design

- Optimal arrangement of sound absorbing materials
- Partition between the cab and engine room



Working Modes Selectable

The PC130-8 excavator is equipped with five working modes (P, E, L, B and ATT mode). Each mode is designed to match engine speed and pump speed with the current application. This provides the flexibility to match equipment performance to the job at hand.

Working Mode	Application	Advantage
P	Power mode	<ul style="list-style-type: none"> • Maximum production/power • Fast cycle times
E	Economy mode	<ul style="list-style-type: none"> • Good cycle times • Better fuel economy • Adjustable in 4 stages
L	Lifting mode	<ul style="list-style-type: none"> • Suitable attachment speed
B	Breaker mode	<ul style="list-style-type: none"> • Optimum engine rpm, hydraulic flow
ATT	Attachment mode	<ul style="list-style-type: none"> • Optimum engine rpm, hydraulic flow, 2 way

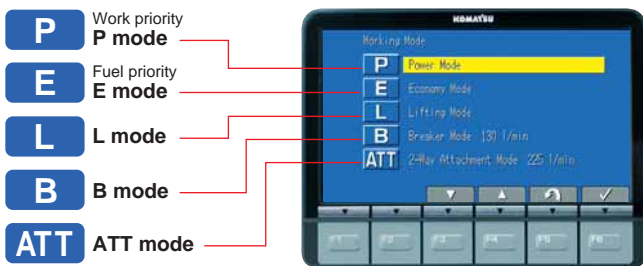

The Economy mode is adjustable in 4 stages. It is selectable from the economy mode adjustment selection menu as appropriate. The power output will be reduced when adjust from E0 to E3, however, the fuel consumption will be better.

Economy Mode Adjustment

E0	Economy mode
E1	Economy Adjustment 1
E2	Economy Adjustment 2
E3	Economy Adjustment 3

ECO Gauge that Assists Energy-saving Operations

The ECO gauge on the right side of the multi-function color monitor provides environment-friendly energy-saving operation. Allows focus on operation in the green range with reduced CO₂ emissions and efficient fuel consumption.



ECO gauge

Idling Caution

To prevent unnecessary fuel consumption, an idling caution is displayed on the monitor, if the engine idles for 5 minutes or more.



Large Digging Force

When press the left knob switch which is called the one-touch power max. switch and when it is kept pressed, this function temporarily increases digging force for 8.5 seconds of operation.

Maximum arm crowd force (ISO 6015):
 61.8 kN (6.3 t) ➔ **67.5 kN (6.8 t) 9% UP**
 (with Power Max.)

Maximum bucket digging force (ISO 6015):
 86.0 kN (8.7 t) ➔ **93.4 kN (9.5 t) 9% UP**
 (with Power Max.)

Measured with Power Max. function, 2500 mm arm and ISO 6015 rating.

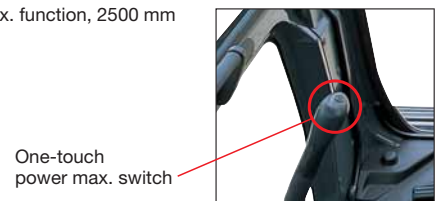

Larger Maximum Drawbar Pull

Larger maximum drawbar pull provides superb steering and slope climbing performance.

Maximum drawbar pull: 122.6 kN 12500 kg



Photo may include optional equipment.

COMFORT



Low-noise Cab

The newly-designed cab is highly rigid and has excellent sound absorption ability. Thorough improvement of noise source reduction and use of low noise engine, hydraulic equipment, and air conditioner allows this machine to generate a low level of noise similar to that of a passenger car.

Low Vibration with Cab Damper Mounting

PC130-8 uses viscous damper mounting for cab that incorporates longer stroke and the addition of a spring. The new cab damper mounting combined with high rigidity deck aids vibration reduction at operator seat.

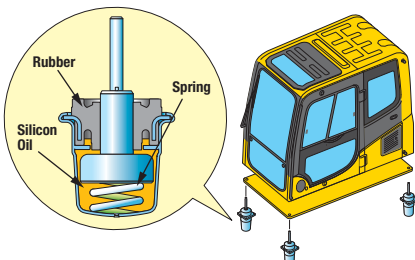

Wide Spacious Cab

Newly-designed wide spacious cab includes seat with reclining backrest. The seat height and longitudinal inclination are easily adjusted using a pull-up lever. You can set the appropriate operational posture of armrest together with the console. Reclining the seat further enables you to place it into the fully flat state with the headrest attached.



Pressurized Cab

A/C, air filter and a higher internal air pressure prevent external dust from entering the cab.

Automatic A/C

Enables you to easily and precisely set cab atmosphere with the instruments on the large LCD. The bi-level control function keeps the operator's head and feet cool and warm respectively. This improved air flow function keeps the inside of the cab comfortable throughout the year. Defroster function keeps front glass clear.

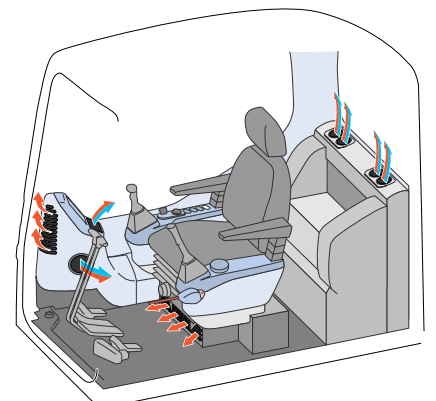

SAFETY

ROPS Cab (ISO 12117-2)

The machine is equipped with a ROPS cab (ISO 12117-2) for excavators as standard equipment. The ROPS cab has high shock-absorption performance, featuring excellent durability and impact strength. It also satisfies the requirements of OPG top guard level 1 (ISO 10262) for falling objects. Combined with the retractable seat belt, The ROPS cab protects the operator in case of tipping over and against falling objects.

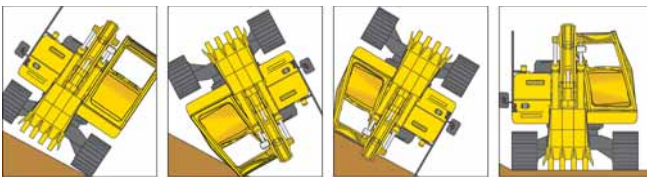

Slip-resistant Plates

Highly durable slip-resistant plates maintain superior traction performance for the long term.



Pump/engine Room Partition

Pump/engine room partition prevents oil from spraying onto the engine if a hydraulic hose should burst.

Lock Lever

Locks the hydraulic pressure to prevent unintentional movement. Neutral start function allows machine to be started only in lock position.



Large Side-view, Sidewise, Rear and Front Under-view Mirrors

Enlarged side mirrors and addition of front under mirror allow the PC130-8 to meet the visibility requirements (ISO 5006).



Rear View Monitor System (Optional)

The operator can view the rear of the machine with a color monitor screen.



Monitor for rear view camera

Thermal and Fan Guards

Thermal and fan guards are placed around high-temperature parts of the engine and fan drive.



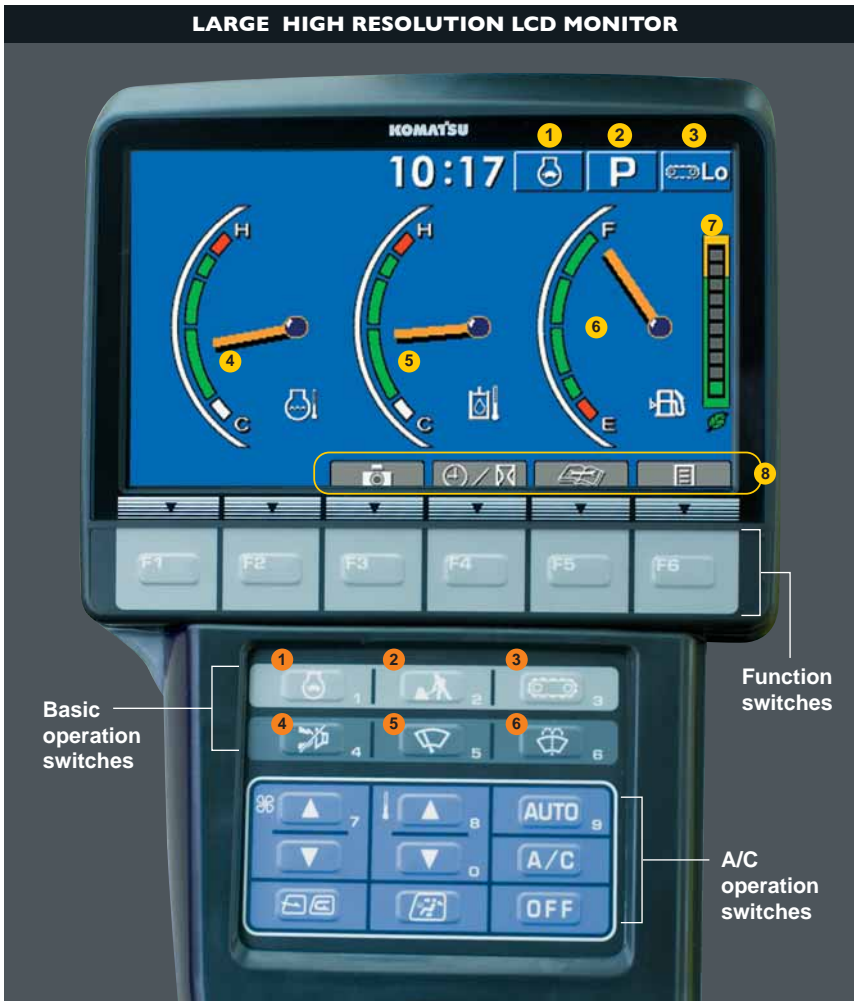

Large LCD Color Monitor

A large user-friendly color monitor enables safe, accurate and smooth work. Improved screen visibility is achieved by the use of LCD that can easily be read at various angles and lighting conditions. Simple and easy to operate switches. Industry first function keys facilitate multi-function operations. Displays data in 12 languages to globally support operators around the world.

Indicators

- 1 Auto-decelerator
- 2 Working mode
- 3 Travel speed
- 4 Engine water temperature gauge
- 5 Hydraulic oil temperature gauge
- 6 Fuel gauge
- 7 ECO gauge
- 8 Function switches menu

Basic operation switches

- 1 Auto-decelerator
- 2 Working mode selector
- 3 Traveling selector
- 4 Buzzer cancel
- 5 Wiper
- 6 Windshield washer

Equipment Management Monitoring System

Monitor function

Controller monitors engine oil level, coolant temperature, battery charge and air clogging, etc. If controller finds any abnormality, it is displayed on the LCD.



Maintenance function

Monitor informs replacement time of oil and filters on LCD when the replacement interval is reached.



Trouble data memory function

Monitor stores abnormalities for effective troubleshooting.

KOMTRAX

The Komatsu remote monitoring and management technology provides insightful data about your equipment and fleet in user-friendly format.

Energy Saving Operation Report

KOMTRAX delivers the energy-saving operation report based on the operating information such as fuel consumption, load summary and idling time, which helps you efficiently run a business.

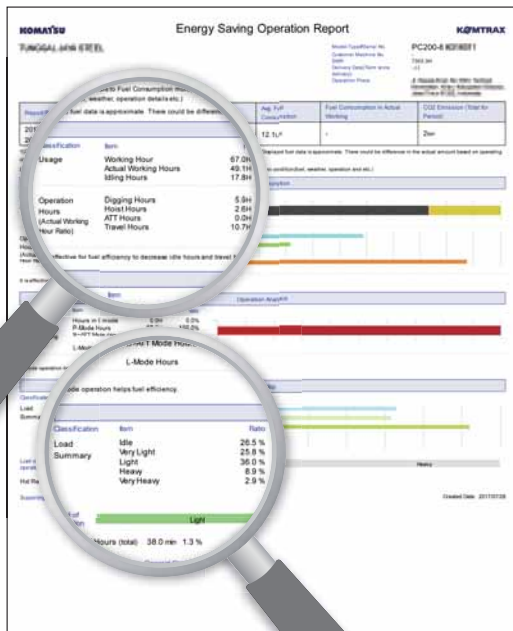

This report image is an example of hydraulic excavator

Equipment Management Support

Through the web application, a variety of search parameters are available to quickly find information about specific machines based on key factors. Moreover, KOMTRAX finds out machines with problems from your fleet and shows you through an optimal interface.

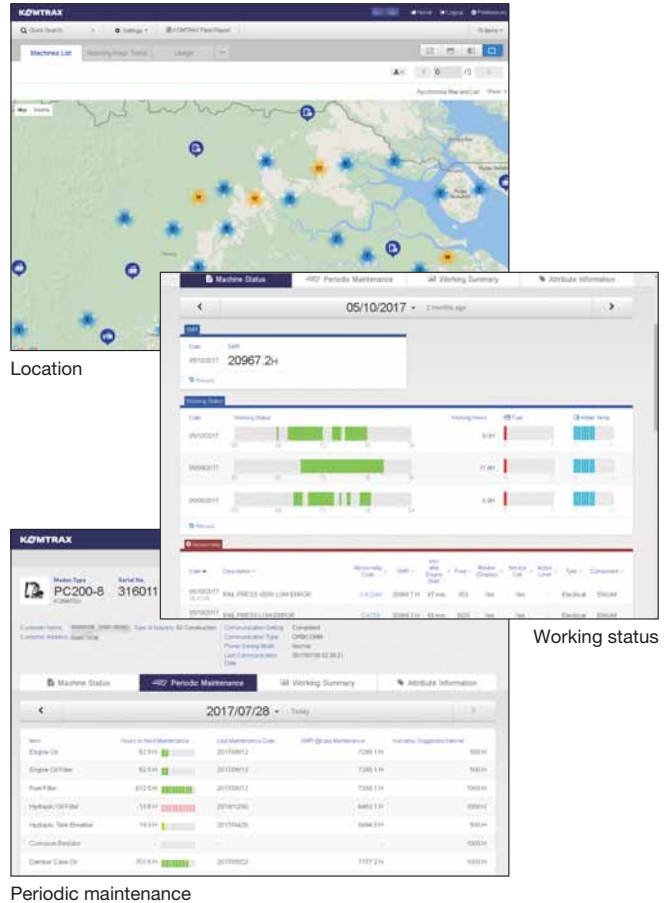

Location

Working status

Periodic maintenance

The report contents and data depend on the machine model.

Optimal Strategy for Efficient Work

The detailed information that KOMTRAX puts at your fingertips helps you manage your fleet conveniently on the web anytime, anywhere. It gives you the power to make better daily and long-term strategic decisions.



RELIABILITY & DURABILITY

High Rigidity Work Equipment

Boom and arms are constructed of thick plates of high tensile strength steel. In addition, these structures are designed with large cross-sectional areas and generous use of castings. The result is working attachments that exhibit long term durability and high resistance to bending and torsional stress.

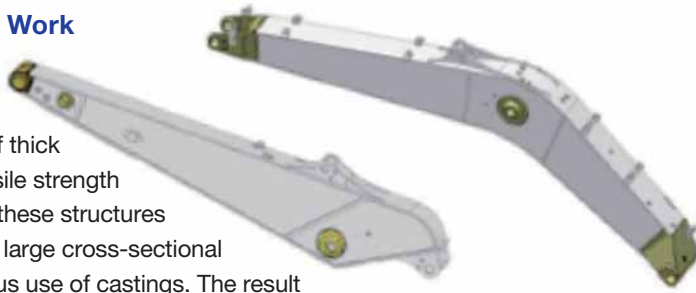

Metal Guard Rings

Metal guard rings protect all the hydraulic cylinders and improve reliability.

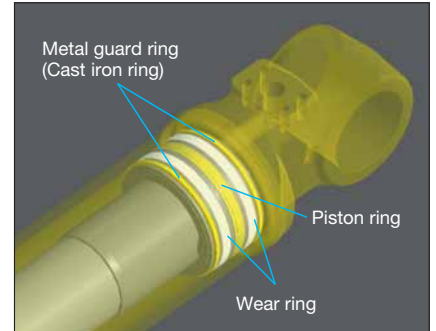

Sealed Connectors

Sealed connectors seal tight and have higher reliability.

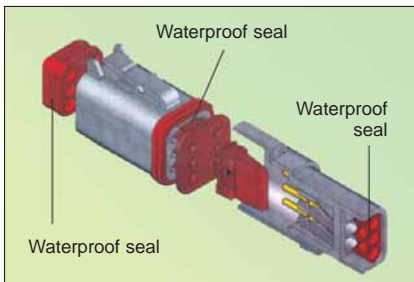

Reliable Components

All of the major machine components, such as engine, hydraulic pump, hydraulic motors and control valves are exclusively designed and manufactured by Komatsu.

O-ring Face Seal

The hydraulic hose seal method has been changed from a conventional taper seal to an O-ring seal. This provides improved sealing performance.



MAINTENANCE

Side-by-side Cooling

Since radiator, aftercooler and oil cooler are arranged in parallel, it is easy to clean, remove and install them. Radiator, aftercooler, and oil cooler made of aluminum have high cooling efficiency and are easily recycled.



Equipped with the Fuel Pre-filter (With Water Separator)

Removes water and contaminants in the fuel to prevent fuel problems. (With built-in priming pump)



Washable Cab Floor Mat

The PC130-8's cab floor mat is easy to keep clean. The gently inclined surface has a flanged floor mat and drainage holes to facilitate runoff.

Easy Access to Engine Oil Filter, Engine Main Fuel Filter and Fuel Drain Valve

Engine oil filter, engine main fuel filter and fuel drain valve are remote mounted to improve accessibility.



Equipped with the Drain Valve as Standard

Prevents clothes and the ground from becoming contaminated due to oil leakage when replacing the engine oil.



Large-capacity Fuel Tank and Rustproof Treatment

247 L high-capacity fuel tank. Effective corrosion resistance using rustproof treatment.

Sloping Track Frame

Prevents dirt and sand from accumulating and allows easy mud removal.

Long-life Oil, Filter

Uses high-performance filtering materials and long-life oil. Extends the oil and filter replacement interval.



Hydraulic oil filter

Engine oil & Engine oil filter	every 500 hours
Hydraulic oil	every 5000 hours
Hydraulic oil filter	every 1000 hours

Easy to Clean A/C Filter

The A/C filter is removed and installed without the use of tools facilitating filter maintenance.



Internal A/C filter



External A/C filter





Long Greasing Interval (Optional)

High quality bushings are optionally available for work equipment pins except arm top pin. All bushing lubrication intervals of work equipment except arm top bushings are 500 hours, reducing maintenance cost.

KOMATSU BRAND BUCKET

KOMATSU Brand Bucket for General Purpose with Wide Bucket Width

Category and Feature

Category	Load / Wear / Soil (Application)	Image	
General Purpose GP	<p>Load Machine power is mostly medium, but occasionally high. Bucket movements are smooth with minor shock load. Bucket penetrates easily.</p> <p>Wear Material is lightly abrasive. Some sand may be medium abrasive.</p> <p>Soil Mostly loose sand, gravel and finely broken materials.</p>		
Heavy Duty HD	<p>Load Machine power is high during majority of the work. Medium, but continuous shock load.</p> <p>Wear Material is abrasive. Light scratch marks can be seen at the bucket.</p> <p>Soil Limestone, shot rock, compact mix of sand, gravel and clay.</p>		

Bucket Line-up

Category	Capacity (m³)	Width (mm)	Weight (kg)	Tooth Quantity	Arm Length		Tooth Type	
					2500 mm	3000 mm	Vertical	Horizontal
GP	0.18	450	256	3	○	○	✓	
	0.28	600	303	3	○	○	✓	✓
	0.36	700	330	4	○	○	✓	✓
	0.50	859	399	4	○	×	✓	✓
	0.60	1000	436	5	□	×	✓	✓
HD	0.50	859	450	4	○	×	✓	✓

○: General purpose use, density up to 1.8 t/m³ □: General purpose use, density up to 1.4 t/m³ ×: Not usable ✓: Selectable

OPTIONS

• Full height guard level 1 (ISO 10262)



• Rain visor



• Sun visor



• Seat, suspension



• Track frame undercover



SPECIAL SPECS.

Attachment Piping Specification

Equips PC130-8 for breaker and crusher installation. Hydraulic flow rate can be regulated by setting Breaker Mode on monitor panel during breaker operation.

Accumulator



Pilot filter
Additional filter for breaker



Stop valve



Operating pedal

Photo may include optional equipment.

ATTACHMENT

Komatsu Genuine Attachment Tool

Komatsu-recommended attachment tools for hydraulic excavators
A wide range of attachment tools are provided to suit customers' specific applications.

Hydraulic breaker

The hydraulic breaker is an attachment tool used for crushing rock beds and paved surfaces, demolishing concrete structures, etc. The large gas chamber, ideal gas pressure ratio, and long-stroke piston deliver a powerful impact force. Since the breaker unit does not require an accumulator, the number of parts has been reduced, resulting in lower maintenance costs.



Crusher

This attachment tool is used for demolishing concrete structures. Since it does not have a striking mechanism and features low noise and low vibration, it is suitable for work in urban areas. The open-close cylinder is equipped with a speed-up valve for increasing work speed.

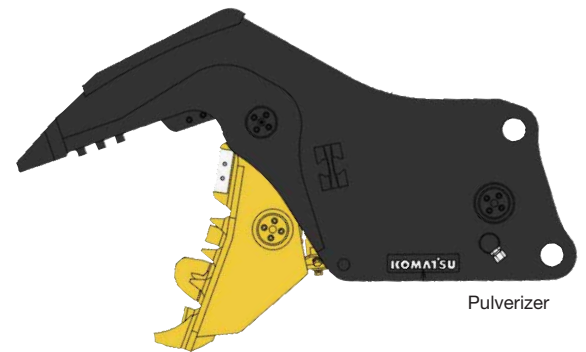

Applications of Attachment Tools

Application/ Attachment Tool	Civil Engineering	Quarry	Demolition	Industrial Waste Disposal	Iron-making	Utility Construction	Rental
Hydraulic Breaker	○	○	○	○	○	○	○
Crusher (Primary Crusher)			○				○
Crusher (Pulverizer)			○	○			○

KOMATSU TOTAL SUPPORT



Komatsu Total Support

To keep your machine available and minimize operation cost when you need it, Komatsu Distributor is ready to provide a variety of supports before and after procuring the machine.

Fleet recommendation

Komatsu Distributor can study the customer's job site and provide the most optimum fleet recommendation with detailed information to meet all of your application needs when you are considering to buy new machines or replace the existing ones from Komatsu.



Product support

Komatsu Distributor gives the proactive support and secures the quality of the machinery that will be delivered.

Parts availability

Komatsu Distributor is available for emergency inquiry by the customers for genuine, quality guaranteed Komatsu parts.

Technical support

Komatsu product support service (Technical support) is designed to help customer. Komatsu Distributor offers a variety of effective services to show how much Komatsu is dedicated to the maintenance and support of Komatsu machine.

- Preventive Maintenance (PM) clinic
- Oil & Wear analysis program
- Undercarriage inspection service, etc.

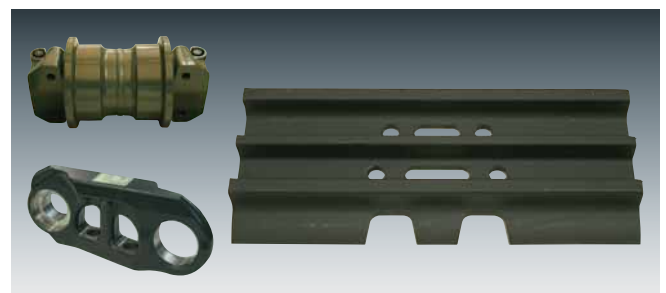

Repair & maintenance service

Komatsu Distributor offers quality repair and maintenance service to the customer, utilizing and promoting Komatsu developed programs.

Komatsu Reman (Remanufactured) components

Komatsu Reman products are the result of the implementation of the Komatsu global policy which establishes and agrees to reduce the owning, operating and total Life Cycle Costs (LCC) to Komatsu's customer through high quality, prompt delivery and competitively priced in own remanufactured products (QDC).



SPECIFICATIONS



ENGINE

Model Komatsu SAA4D95LE-5
 Type Water-cooled, 4-cycle, direct injection
 Aspiration Turbocharged, aftercooled
 Number of cylinders 4
 Bore 95 mm
 Stroke 115 mm
 Piston displacement 3.26 L
 Horsepower:
 SAE J1995 Gross 72.1 kW 96.6 HP
 ISO 9249 / SAE J1349 Net 68.4 kW 91.7 HP
 Rated rpm 2200 min⁻¹
 Fan drive method for radiator cooling Mechanical
 Governor All-speed control, electronic

U.S. EPA Tier 3 and EU Stage 3A emissions certified.



HYDRAULICS

Type .. HydraulMind (Hydraulic Mechanical Intelligence New Design) system, closed-center system with load sensing valves and pressure compensated valves
 Number of selectable working modes 5
 Main pump:
 Type Variable displacement piston type
 Pumps for Boom, arm, bucket, swing, and travel circuits
 Maximum flow 241.5 L/min
 Supply for control circuit Self-reducing valve
 Hydraulic motors:
 Travel 2 x axial piston motor with parking brake
 Swing 1 x axial piston motor with swing holding brake
 Relief valve setting:
 Implement circuits 31.9 MPa 325 kg/cm²
 Travel circuit 34.8 MPa 355 kg/cm²
 Swing circuit 24.7 MPa 252 kg/cm²
 Pilot circuit 3.2 MPa 33 kg/cm²
 Hydraulic cylinders:
 (Number of cylinders – bore x stroke x rod diameter)
 Boom 2–105 mm x 995 mm x 70 mm
 Arm 1–115 mm x 1175 mm x 75 mm
 Bucket: 1–95 mm x 885 mm x 65 mm



DRIVES AND BRAKES

Steering control Two levers with pedals
 Drive method Hydrostatic
 Maximum drawbar pull 122.6 kN 12500 kg
 Gradeability 70%, 35°
 Maximum travel speed: High 5.5 km/h
 Low 2.9 km/h
 Service brake Hydraulic lock
 Parking brake Mechanical disc brake



SWING SYSTEM

Drive method Hydrostatic
 Swing reduction Planetary gear
 Swing circle lubrication Grease-bathed
 Service brake Hydraulic lock
 Holding brake/Swing lock Mechanical disc brake
 Swing speed 11.0 rpm



UNDERCARRIAGE

Center frame X-frame
 Track frame Box-section
 Seal of track Sealed track
 Track adjuster Hydraulic
 Number of shoes (Each side) 43
 Number of carrier rollers (Each side) 1
 Number of track rollers (Each side) 7



COOLANT AND LUBRICANT CAPACITY (REFILLING)

Fuel tank 247 L
 Coolant 13.9 L
 Engine 11.5 L
 Final drive (Each side) 2.1 L
 Swing drive 2.5 L
 Hydraulic tank 90 L



OPERATING WEIGHT (APPROXIMATE)

Operating weight including 4600 mm one-piece boom, 2500 mm arm, ISO 7451 heaped 0.50 m³ backhoe bucket, rated capacity of lubricants, coolant, full fuel tank, operator, and standard equipment.

Shoes	Operating Weight	Ground Pressure
500 mm	12380 kg	38.6 kPa 0.39 kg/cm ²
600 mm	12560 kg	32.6 kPa 0.33 kg/cm ²
700 mm	12740 kg	28.4 kPa 0.29 kg/cm ²



DIMENSIONS

Arm Length		2500 mm	3000 mm
A	Overall length	7590 mm	7485 mm
B	Length on ground (Transport)	4410 mm	4280 mm
C	Overall height (To top of boom)	2875 mm	3185 mm
D	Overall width	2500 mm	
E	Overall height (To top of cab)	2855 mm	
F	Ground clearance, counterweight	895 mm	
G	Ground clearance (Minimum)	400 mm	
H	Tail swing radius	2190 mm	
I	Track length on ground	2880 mm	
J	Track length	3610 mm	
K	Track gauge	1990 mm	
L	Width of crawler	2490 mm	
M	Shoe width	500 mm	
N	Grouser height	20 mm	
O	Machine cab height	1925 mm	
P	Machine cab width	2500 mm	
Q	Distance, swing center to rear end	2110 mm	

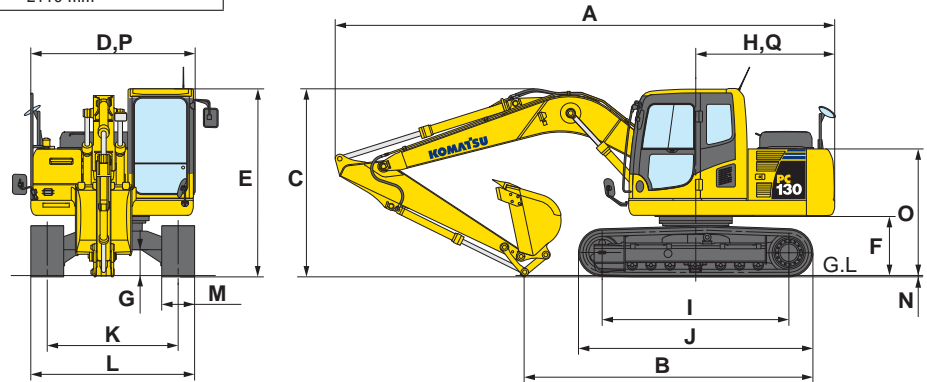

WORKING RANGE

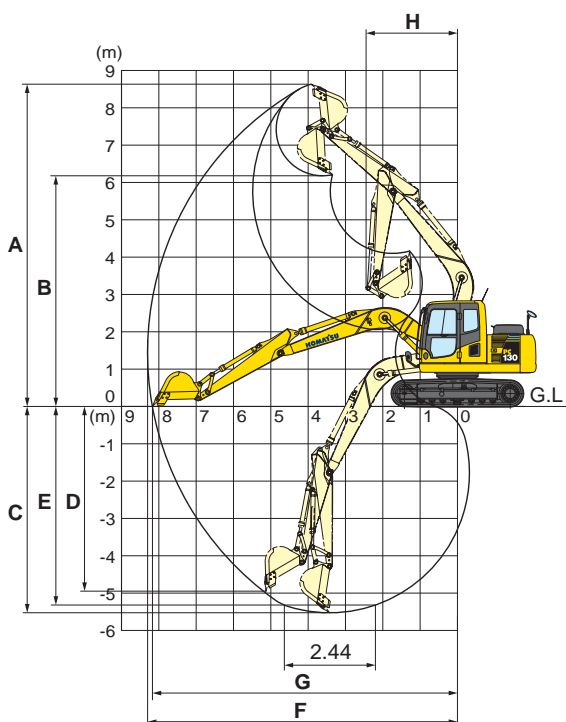

Arm Length		2500 mm	3000 mm
A	Max. digging height	8650 mm	8930 mm
B	Max. dumping height	6210 mm	6615 mm
C	Max. digging depth	5520 mm	5955 mm
D	Max. vertical wall digging depth	4980 mm	5365 mm
E	Max. digging depth of cut for 2440 mm level	5320 mm	5775 mm
F	Max. digging reach	8290 mm	8720 mm
G	Max. digging reach at ground level	8170 mm	8595 mm
H	Min. swing radius	2450 mm	2620 mm
SAE 1179 Rating	Bucket digging force at power max.	80.9 kN 8250 kg	80.9 kN 8250 kg
	Arm crowd force at power max.	64.5 kN 6580 kg	56.8 kN 5800 kg
ISO 6015 Rating	Bucket digging force at power max.	93.4 kN 9520 kg	93.4 kN 9520 kg
	Arm crowd force at power max.	67.5 kN 6880 kg	59.3 kN 6050 kg



LIFTING CAPACITY WITH LIFTING MODE

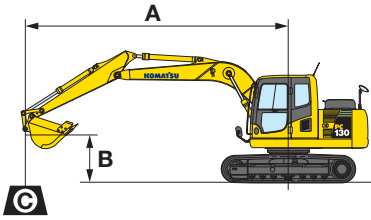

PC130-8

- A: Reach from swing center
- B: Bucket hook height
- C: Lifting capacity
- Cf: Rating over front
- Cs: Rating over side
- ☉: Rating at maximum reach

PC130-8 Boom: 4600 mm Arm: 2500 mm Bucket: 0.50 m ³ ISO 7451 heaped Shoe: 500 mm triple grouser												
B \ A	☉ MAX		7.6 m		6.1 m		4.6 m		3.0 m		1.5 m	
	Cf	Cs	Cf	Cs	Cf	Cs	Cf	Cs	Cf	Cs	Cf	Cs
7.6 m												
6.1 m	*1950 kg	*1950 kg										
4.6 m	*1800 kg	1650 kg			2850 kg	1950 kg	*3100 kg	*3100 kg				
3.0 m	*1800 kg	1400 kg			2750 kg	1900 kg	*3900 kg	3100 kg	*5000 kg	*5000 kg		
1.5 m	1950 kg	1300 kg			2700 kg	1800 kg	4300 kg	2900 kg	*7700 kg	5500 kg		
0 m	1950 kg	1300 kg			2600 kg	1700 kg	4100 kg	2700 kg	8350 kg	5100 kg		
-1.5 m	2200 kg	1450 kg			2550 kg	1700 kg	3900 kg	2500 kg	8200 kg	5000 kg	*4750 kg	*4750 kg
-3.0 m	2800 kg	1850 kg					4050 kg	2650 kg	*7850 kg	5050 kg	*8000 kg	*8000 kg

PC130-8 Boom: 4600 mm Arm: 3000 mm Bucket: 0.50 m ³ ISO 7451 heaped Shoe: 500 mm triple grouser												
B \ A	☉ MAX		7.6 m		6.1 m		4.6 m		3.0 m		1.5 m	
	Cf	Cs	Cf	Cs	Cf	Cs	Cf	Cs	Cf	Cs	Cf	Cs
7.6 m	*1850 kg	*1850 kg					*2050 kg	*2050 kg				
6.1 m	*1500 kg	*1500 kg			*1850 kg	*1850 kg						
4.6 m	*1400 kg	1400 kg			*2700 kg	1950 kg						
3.0 m	*1400 kg	1200 kg	*1550 kg	1200 kg	2750 kg	1900 kg	*3400 kg	3150 kg				
1.5 m	*1500 kg	1100 kg	1800 kg	1150 kg	2650 kg	1800 kg	4350 kg	2900 kg	*6650 kg	5500 kg		
0 m	1700 kg	1100 kg	1750 kg	1100 kg	2550 kg	1700 kg	4100 kg	2700 kg	8350 kg	5050 kg		
-1.5 m	1900 kg	1200 kg			2500 kg	1600 kg	3850 kg	2450 kg	8100 kg	4850 kg	*4150 kg	*4150 kg
-3.0 m	2300 kg	1500 kg			2500 kg	1600 kg	3900 kg	2550 kg	8100 kg	4850 kg	*6750 kg	*6750 kg
-4.6 m	*3350 kg	2350 kg					*3950 kg	2650 kg	*6250 kg	5050 kg		

* Load is limited by hydraulic capacity rather than tipping. Ratings are based on SAE J1097. Rated loads do not exceed 87% of hydraulic lift capacity or 75% of tipping load.

**STANDARD EQUIPMENT****ENGINE:**

- Automatic engine warm-up system
- Dry type air cleaner, double element
- Engine, Komatsu SAA4D95LE-5
- Engine overheat prevention system
- Radiator and oil cooler dust proof net
- Suction fan

ELECTRICAL SYSTEM:

- Alternator, 24 V/35 A
- Auto-decelerator
- Batteries, 2 X 12 V/64 Ah
- Starting motor, 24 V/4.5 kW
- Working light, 2 (Boom and RH)

HYDRAULIC SYSTEM:

- Boom holding valve
- Power maximizing system
- Pressure Proportional Control (PPC) hydraulic control system
- Working mode selection system

GUARDS AND COVERS:

- Fan guard structure

UNDERCARRIAGE:

- Hydraulic track adjusters (Each side)
- Track roller
 - 7 each side
- Track shoe
 - 500 mm triple grouser

OPERATOR ENVIRONMENT:

- A/C with defroster
- Equipment Management Monitoring System
- Front underview mirror
- Large multi-lingual high resolution LCD monitor
- Rear view mirrors (RH, LH, rear, sidewise)
- ROPS cab (ISO 12117-2)

OTHER EQUIPMENT:

- Counterweight
- Electric horn
- Rear reflector
- Seat belt, retractable
- Slip-resistant plates
- Travel alarm

**OPTIONAL EQUIPMENT****ENGINE:**

- Additional filter system for poor-quality fuel (Water separator)

ELECTRICAL SYSTEM:

- Alternator, 24 V/60 A
- Batteries, large capacity
- Working lights
 - 2 on cab
 - 1 on counterweight

HYDRAULIC SYSTEM:

- Long lubricating intervals for work equipment bushing (500 hours)
- Service valve

UNDERCARRIAGE:

- Shoes, triple grouser
 - 600 mm
 - 700 mm
- Track frame undercover
- Track roller guards (Center section)

OPERATOR ENVIRONMENT:

- Bolt-on top guard, OPG top guard level 2 (ISO 10262)
- Cab accessories
 - Rain visor
 - Sun visor

- Cab front guard
 - Full height guard level 1 (ISO 10262)
 - Half height guard
- Rear view monitor system
- Seat, suspension

WORK EQUIPMENT:

- Arms
 - 2500 mm arm assembly
 - 3000 mm arm assembly
- Boom
 - 4600 mm

